

# ESPEJOS

baño/  
bath

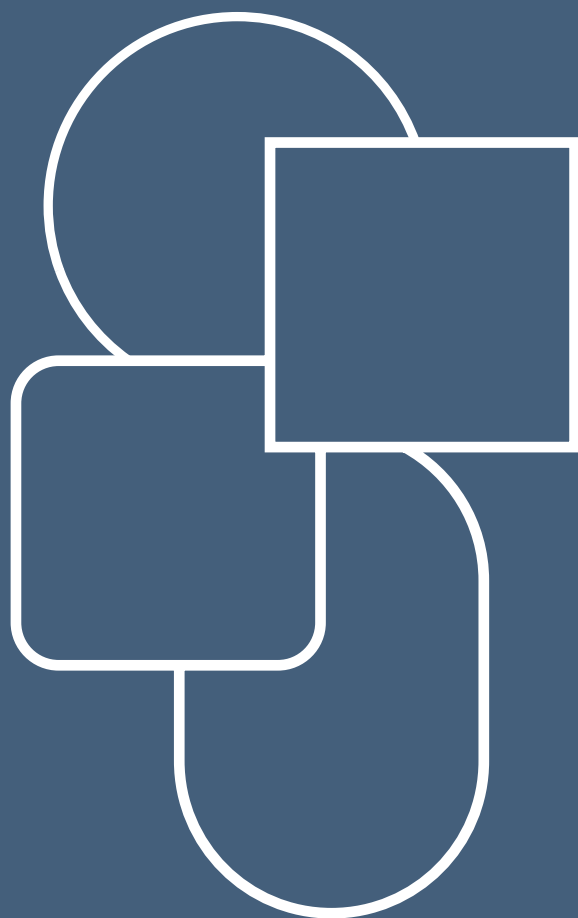

2024  
/2025

MANILLONS TORRENT

# MIRRORS

# MANILLONS TORRENT

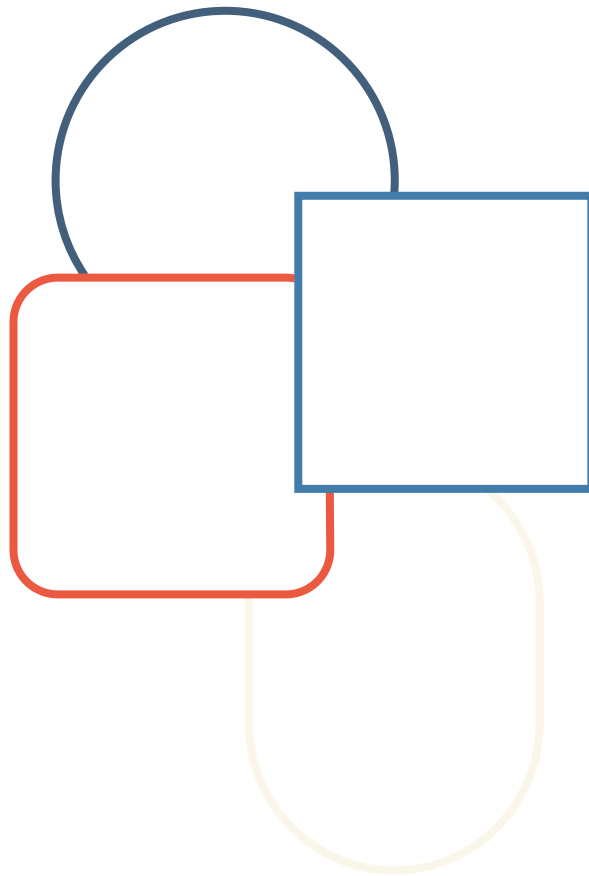

2024/2025

# índice

# índice

07 – 13

intro/intro

15 – 41

canto recto/straight edge

17 Basic	31 Nova
19 Retro	33 Clio
21 Extend H/V	35 Stripe
23 Classic	37 Line
25 Mix	39 Marcus
27 Bria	41 Lexus
29 White	

43 – 61

canto redondo/round edge

45 Green	55 Nao
47 Brisa	57 Vitara
49 Ona	59 Vitara Vestidor
51 Ondra	61 Tango
53 Ondra Vestidor	

63 – 85

circular/circular

65 Alvero	77 Arena
67 Alba	79 Circular
69 Bruma	81 Eclipse
71 Moon	83 Bolero
73 Sun	85 Hula
75 Redondo	

87 – 105

cápsula/capsule

89 Luk	99 Dante
91 Aura	101 Oval
93 Calas	103 Circus
95 Calas Vestidor	105 Swing
97 Eros	

106 – 107

a medida/bespoke

109 – 119

info. técnica/technical info.

120 – 121

legal/legal



En Manillons Torrent, nuestra pasión es transformar tu baño en un espacio íntimo y acogedor donde puedas disfrutar de momentos de tranquilidad y bienestar. Nuestro viaje comenzó en el mundo de los manillones de puertas, y a lo largo de los años, hemos evolucionado hacia los accesorios y complementos de baño. En los últimos años, hemos dado un paso firme introduciéndonos en el mundo de los espejos y espejos LED.

Nuestra misión es simple pero ambiciosa: encontrar el espejo perfecto para tu baño.

Orientamos nuestros esfuerzos en ofrecer toda una gama de espejos concebidos bajo los criterios del buen producto: calidad, saber hacer, atención al detalle y diseño como elemento principal de cada uno de ellos.

Trabajamos tratando de repensar la forma de hacer y de producir. Intentando redefinir el mundo de los espejos del baño, de manera que investigamos nuevas maneras de fabricar e innovar desde un punto de vista local pero con una perspectiva global.

Nuestros espejos no solo iluminan tu baño, sino que también lo completan. Te invitamos a explorar nuestra nueva colección y descubrir cómo podemos hacer que tu paso por el baño sea una experiencia más agradable, cómoda y confortable.

Our passion at Manillons Torrent is to transform your bathroom into an intimate and welcoming space where you can enjoy moments of tranquility and well-being. Our journey began in the world of door handles, and over the years, we have evolved to bathroom accessories and complements. In recent years, we have taken a firm step towards the world of mirrors and LED mirrors.

Our mission is simple but ambitious: find the perfect mirror for your bathroom.

We focus our efforts on offering a range of mirrors conceived under the criteria of a good product: quality, know-how, caring about details and design as the main element of each of them.

We work trying to rethink the way of doing and producing. Trying to redefine the world of bathroom mirrors, so we investigate new ways of producing and innovating from a local point of view but with a global perspective.

Our mirrors not only illuminate your bathroom, they also complete it. We invite you to explore our new collection and discover how we can make your time in the bathroom a more pleasant and comfortable experience.

# made in spain

Apostando por el made in Spain, buscamos repensar la forma de fabricar y producir, volviendo a nuestros orígenes y apoyándonos en nuestra experiencia industrial en el sector del metal. Extraemos todo ese conocimiento y lo incorporamos a todas nuestras nuevas familias de espejos. Producción local como sello de calidad y apuesta por una producción más sostenible.

Diseñamos, fabricamos y distribuimos con todos estos criterios como máxima, con el fin de ofrecerte un producto de calidad.

Relying on the made in Spain, we seek to rethink the way we manufacture and produce, returning to our origins and taking advance on our industrial experience in metal fabrication. We extract all that knowledge and incorporate it into our new families of mirrors. A local manufacturing as a mark of quality and commitment to a more sustainable production.

We design, produce and distribute with all these criteria as a core idea, in order to offer you a quality product.



diseño  
calidad  
distribución



design  
quality  
distribution



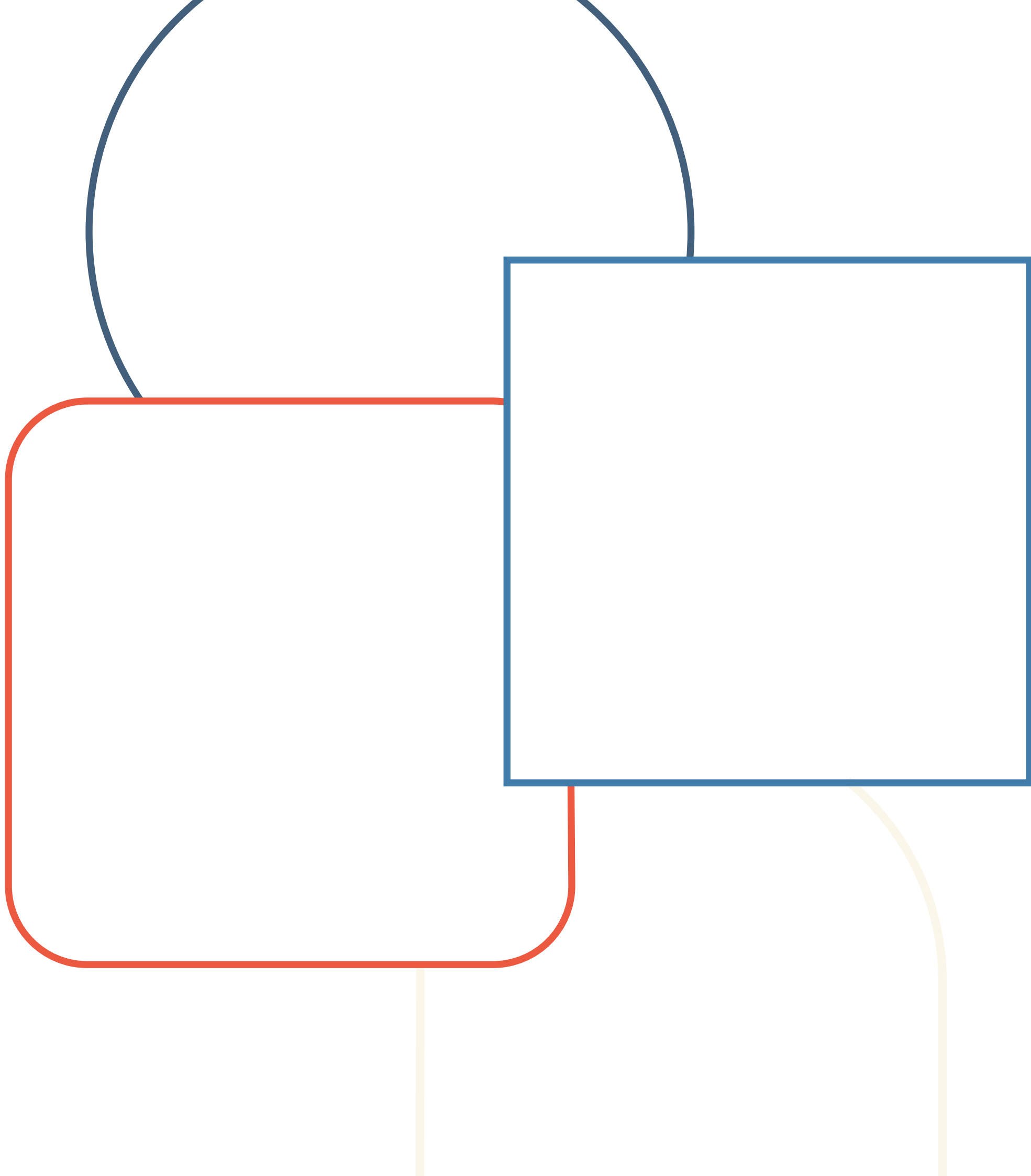

colecciones  
/collections

# info. general

# /general info

En Manillons Torrent, estamos comprometidos en ofrecerte espejos de alta calidad. Trabajamos rigurosamente con estándares de calidad que buscan brindarte las mejores especificaciones y funcionalidades en espejos para tu baño. Todos nuestros productos comparten estas características generales como punto de partida.

At Manillons Torrent, we are committed to offering you high quality mirrors. We work rigorously with quality standards that seek to provide you with the best specifications and functionalities in mirrors for your bathroom. All our products share these general characteristics as a starting point.

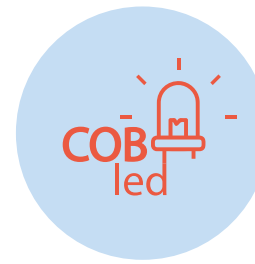

Led COB  
COB Led



Temperatura de Luz  
Light Temperature



Protección  
Protection

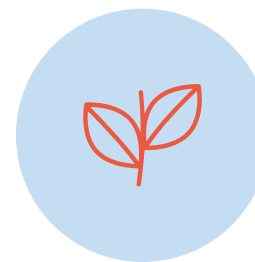

Sostenible  
Sustainable

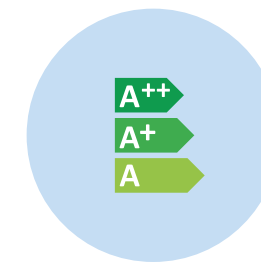

Bajo Consumo  
Energy Efficient



Vida Útil  
Life Cycle



Anticorrosión  
Antirust



3 Años de Garantía  
3 Years Warranty



Cristal Libre de Cobre  
Copper Free Glass



Todo comienza con cuatro líneas rectas y sencillas que se entrelazan entre sí, formando un espejo cuadrado perfecto. Estático, limpio y puro. Este cuadrado crece y disminuye, adaptándose a cada espacio.

It all starts with four simple straight lines that intertwine each other, forming a perfect square mirror. Static, clean and pure. This square grows and shrinks, to fit each space.

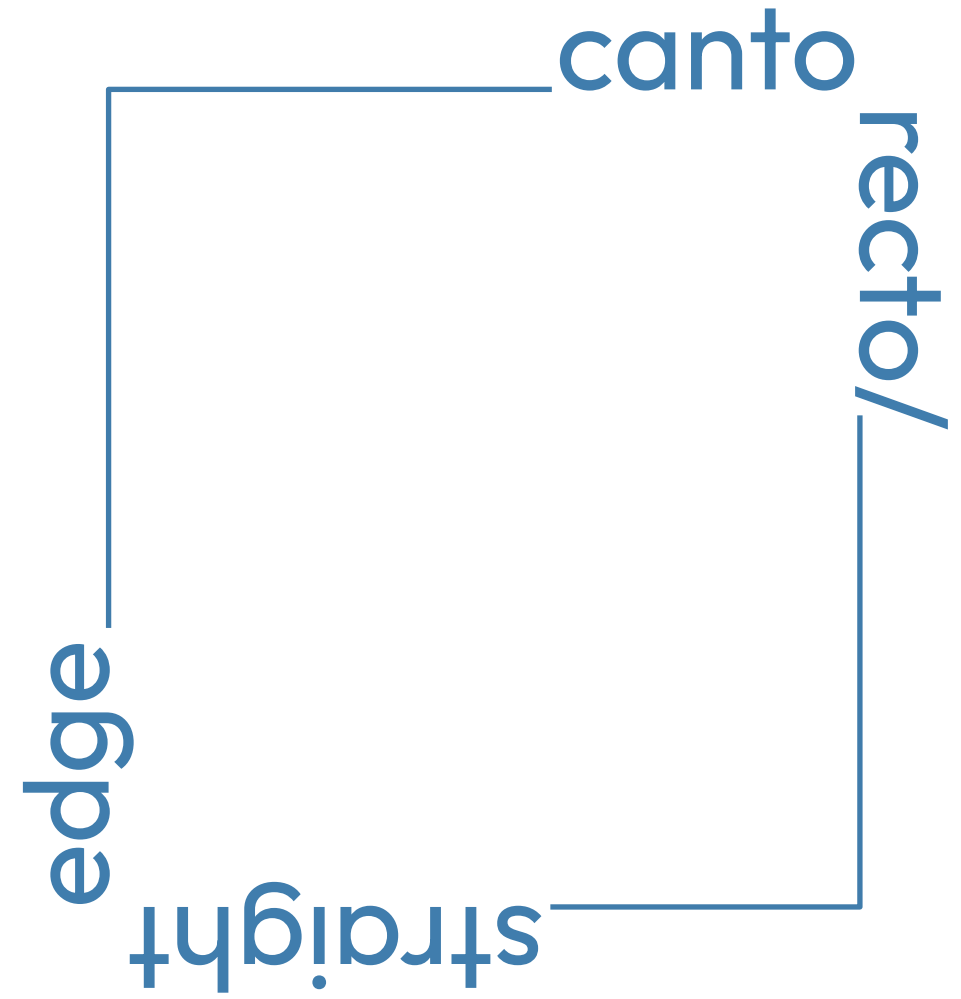



## basic

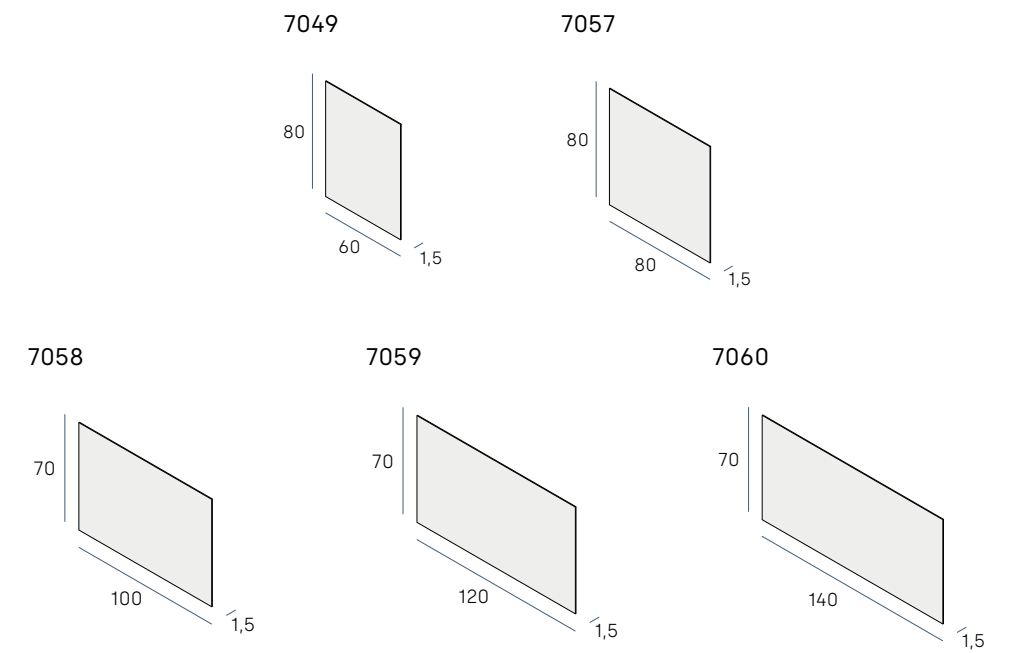

es Colección Basic, cristal de canto pulido recto con 4 mm de espesor. Fijación mediante pletinas metálicas.

ENG Basic collection, straight edges mirror with 4 mm glass thickness. Fixing metal plates.

Dimensión/ Dimension	Referencia/ Reference	Vertical/Horizontal
60 x 80	7049	✓
80 x 80	7057	V
100 x 70	7058	✓
120 x 70	7059	H
140 x 70	7060	H

# retro

## LUZ RETROILUMINADA BACKLIT LIGHT

7068/7247

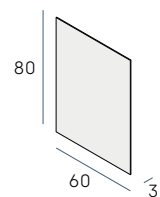

7070/7248

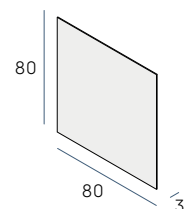

7071/7249

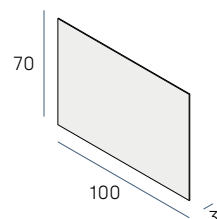

7072/7250

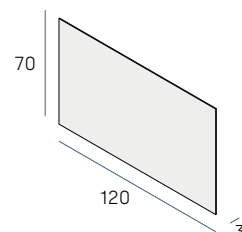

7122/7251

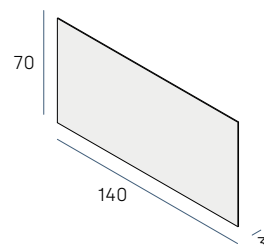

es Colección Retro con conexión directa a red. Cristal de canto recto con 4 mm de espesor. Luz retroiluminada de 5500 °K. Bastidor de PVC con sistema de fijación regulable y nivelable.

ENG Retro collection, with direct connection to mains. Straight edges with 4 mm glass thickness. 5500 °K backlit light. PVC inner frame with adjustable fixing system.

• Versión Plus/  
Plus Version



Incluye sensor touch on/off luz, antivaho y dimmer.

Includes on/off light, defogger and dimmer touch sensor.

Dimensión/ Dimension	Ref/ Ref	On/Off Luz On/Off Light	Regulación Luz/ Dimmer	Antivaho/ Defogger	T.º de Luz/ Light Temp.	Lumens/ Lumens	Potencia/ Power
60 x 80	7068	-	-	-	5500 °K	2112 Lm	21 W
	• 7247	✓	✓	✓			
80 x 80	7070	-	-	-	5500 °K	2432 Lm	24 W
	• 7248	✓	✓	✓			
100 x 70	7071	-	-	-	5500 °K	2592 Lm	26 W
	• 7249	✓	✓	✓			
120 x 70	7072	-	-	-	5500 °K	2912 Lm	29 W
	• 7250	✓	✓	✓			
140 x 70	7122	-	-	-	5500 °K	3232 Lm	32 W
	• 7251	✓	✓	✓			

Sobre pedido  
Upon request

Cambio de temperatura de luz: 3000 °K o 4200 °K  
Change of light temperature: 3000 °K or 4200 °K





## extend h/v

LUZ FRONTAL  
FRONTAL LIGHT

7102

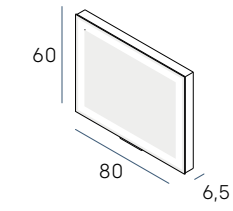

7103

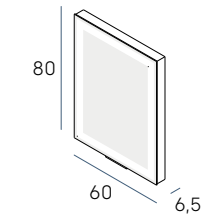

es Colección Extend con conexión directa a red. Cristal de canto recto con 4 mm de espesor y arenado de 48 mm. Luz frontal de 5500 °K y sistema de fijación extensible.

ENG Extend Collection with direct connection to mains. Straight edges with 4 mm glass thickness and 48 mm sandblasting area. 5500 °K front light and extendable fixing system.

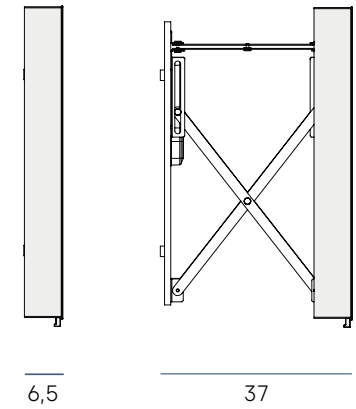

Dimensión/ Dimension	Ref/ Ref	T.º de Luz/ Light Temp.	Lumens/ Lumens	Potencia/ Power
80 x 60	7102	5500 °K	1270 Lm	17 W
60 x 80	7103	5500 °K	1270 Lm	17 W

# classic

LUZ FRONTAL  
FRONTAL LIGHT

7077/7269

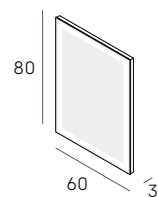

7078/7270

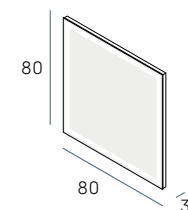

7079/7271

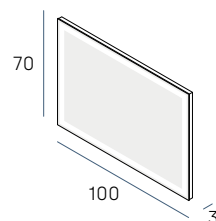

7080/7273

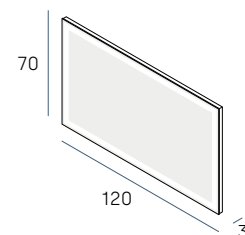

7141/7274

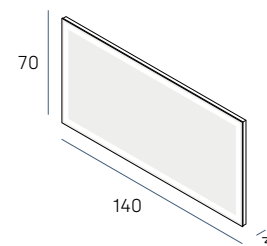

ES Colección Classic con conexión directa a red.  
Cristal de canto recto con 4 mm de espesor y are-  
nado de 33 mm. Luz frontal de 5500 °K. Bastidor de  
PVC con sistema de fijación regulable y nivelable.

ENG Classic collection with direct connection to  
mains. Straight edges with 4 mm glass thickness  
and 33 mm sandblasting area. 5500 °K front light.  
PVC inner frame with adjustable fixing system.

• Versión Plus/  
Plus Version



Incluye sensor touch on/off antivaho.  
Includes on/off defogger touch sensor.

Dimensión/ Dimension	Ref/ Ref	On/Off Antivaho/ On/Off Defogger	T.º de Luz/ Light Temp.	Lumens/ Lumens	Potencia/ Power
60 x 80	7077	-	5500 °K	1792 Lm	18 W
	• 7269	✓			
80 x 80	7078	-	5500 °K	2112 Lm	21 W
	• 7270	✓			
100 x 70	7079	-	5500 °K	2272 Lm	23 W
	• 7271	✓			
120 x 70	7080	-	5500 °K	2592 Lm	26 W
	• 7273	✓			
140 x 70	7141	-	5500 °K	2912 Lm	29 W
	• 7274	✓			

Sobre pedido  
Upon request

Cambio de temperatura de luz: 3000 °K o 4200 °K  
Change of light temperature: 3000 °K or 4200 °K



es Colección Mix. Cristal de canto recto con 4 mm de espesor. Marco exterior de aluminio con sistema de fijación regulable.

eng Mix collection. Straight edges mirror with 4 mm thickness. Aluminium outer frame with adjustable fixing system.

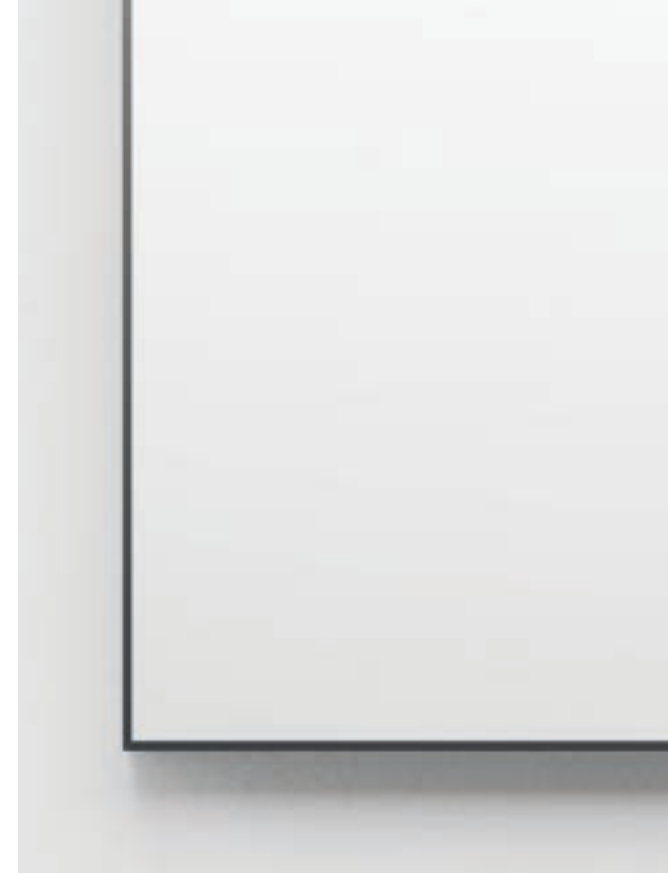

7114

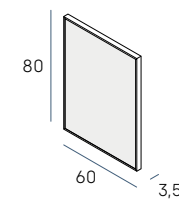

7115

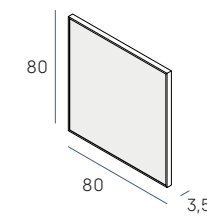

7116

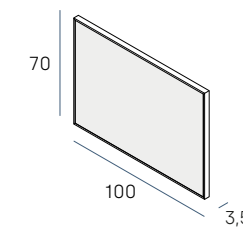

7117

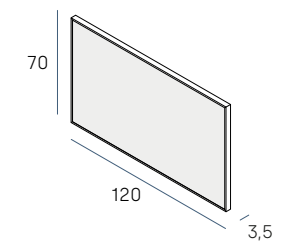

Dimensión/ Dimension	Referencia/ Reference	Vertical/Horizontal
60 x 80	7114	✓
80 x 80	7115	V
100 x 70	7116	✓
120 x 70	7117	H

Acabados/  
Finishes





# bria

## LUZ FRONTAL Y RETROILUMINADA FRONTAL AND BACKLIT LIGHT

7136/7264

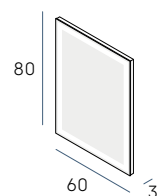

7137/7265

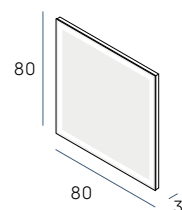

7138/7266

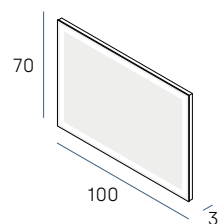

7139/7267

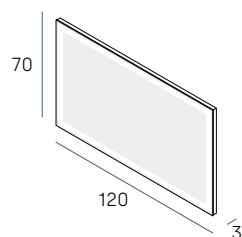

7140/7268

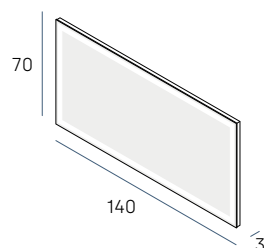

es Colección Bria con conexión directa a red. Cristal de canto recto con 4 mm de espesor y arenado de 33 mm. Luz frontal y retroiluminada de 5500 °K. Bastidor de PVC con sistema de fijación regulable y nivelable.

ENG Bria collection with direct connection to mains. Straight edges with 4 mm glass thickness and 33 mm sandblasting area. 5500 °K front and backlit light. PVC inner frame with adjustable fixing system.

- Versión Plus/  
Plus Version



Incluye sensor touch on/off luz, antivaho y dimmer  
Includes on/off light, defogger and dimmer touch sensor.

Dimensión/ Dimension	Ref/ Ref	On/Off Luz On/Off Light	Regulación Luz/ Dimmer	Antivaho/ Defogger	T.º de Luz/ Light Temp.	Lumens/ Lumens	Potencia/ Power
60 x 80	7136	-	-	-	5500 °K	1792 Lm	18 W
	• 7264	✓	✓	✓			
80 x 80	7137	-	-	-	5500 °K	2112 Lm	21 W
	• 7265	✓	✓	✓			
100 x 70	7138	-	-	-	5500 °K	2272 Lm	23 W
	• 7266	✓	✓	✓			
120 x 70	7139	-	-	-	5500 °K	2592 Lm	26 W
	• 7267	✓	✓	✓			
140 x 70	7140	-	-	-	5500 °K	2912 Lm	29 W
	• 7268	✓	✓	✓			

Sobre pedido  
Upon request

Cambio de temperatura de luz: 3000 °K o 4200 °K  
Change of light temperature: 3000 °K or 4200 °K



# white

LUZ RETROILUMINADA  
BACKLIT LIGHT

7126/7253

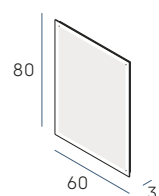

7127/7254

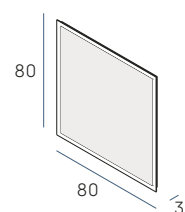

7128/7255

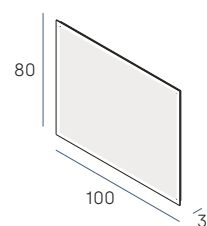

7129/7256

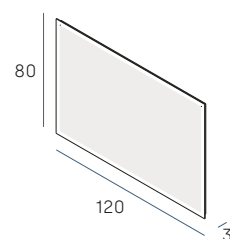

es Colección White con conexión directa a red. Cristal de canto recto con 4 mm de espesor y arenado de 30 mm. Luz retroiluminada de 5500 °K. Bastidor de PVC con sistema de fijación regulable y nivelable.

ENG White collection with direct connection to mains. Straight edges with 4 mm glass thickness and 30 mm sandblasting area. 5500 °K backlit light. PVC inner frame with adjustable fixing system.

• Versión Plus/  
Plus Version



Incluye sensor touch on/off luz, antivaho y dimmer.  
Includes on/off light, defogger and dimmer touch sensor.

Dimensión/ Dimension	Ref/ Ref	On/Off Luz On/Off Light	Regulación Luz/ Dimmer	Antivaho/ Defogger	T.º de Luz/ Light Temp.	Lumens/ Lumens	Potencia/ Power
60 x 80	7126	-	-	-	5500 °K	1920 Lm	19 W
	• 7253	✓	✓	✓			
80 x 80	7127	-	-	-	5500 °K	2240 Lm	22 W
	• 7254	✓	✓	✓			
100 x 80	7128	-	-	-	5500 °K	2560 Lm	26 W
	• 7255	✓	✓	✓			
120 x 80	7129	-	-	-	5500 °K	2880 Lm	29 W
	• 7256	✓	✓	✓			

Sobre pedido  
Upon request

Cambio de temperatura de luz: 3000 °K o 4200 °K  
Change of light temperature: 3000 °K or 4200 °K







**nova**

**LUZ FRONTAL  
FRONTAL LIGHT**

es Colección Nova con conexión directa a red. Cristal de canto recto con 4 mm de espesor y arenado de 30 mm. Luz frontal de 5500 °K. Con marco exterior de aluminio y bastidor de PVC con sistema de fijación regulable y nivelable.

ENG Nova collection with direct connection to mains. Straight edges with 4 mm glass thickness and 30 mm sandblasting area. 5500 °K front light. External aluminium frame and PVC inner frame with adjustable and leveling fixing system.

- Versión Plus/  
Plus Version



Incluye sensor touch on/off luz, antivaho y dimmer.  
Includes on/off light, defogger and dimmer touch sensor.

7131/7258

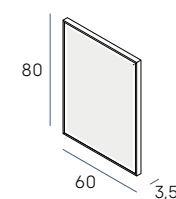

7132/7259

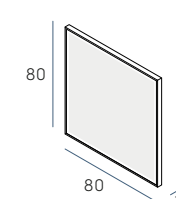

7133/7260

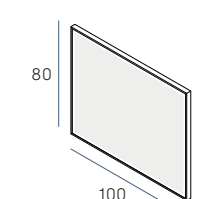

7134/7261

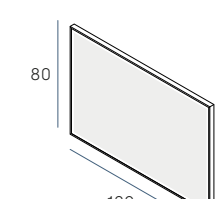

Dimensión/ Dimension	Ref/ Ref	On/Off Luz On/Off Light	Regulación Luz/ Dimmer	Antivaho/ Defogger	T.º de Luz/ Light Temp.	Lumens/ Lumens	Potencia/ Power
60 x 80	7131	-	-	-	5500 °K	1920 Lm	19 W
	• 7258	✓	✓	✓			
80 x 80	7132	-	-	-	5500 °K	2240 Lm	22 W
	• 7259	✓	✓	✓			
100 x 80	7133	-	-	-	5500 °K	2560 Lm	26 W
	• 7260	✓	✓	✓			
120 x 80	7134	-	-	-	5500 °K	2880 Lm	29 W
	• 7261	✓	✓	✓			

Sobre pedido  
Upon request

Cambio de temperatura de luz: 3000 °K o 4200 °K  
Change of light temperature: 3000 °K or 4200 °K

Acabados/  
Finishes



Inox. Cepillado  
Brushed St. Steel



Oro Cepillado  
Brushed Gold



Negro Mate  
Matt Black



# clio

LUZ FRONTAL Y RETROILUMINADA  
FRONTAL AND BACKLIT LIGHT

7099

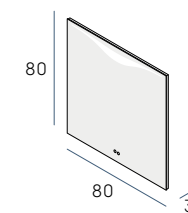

7100

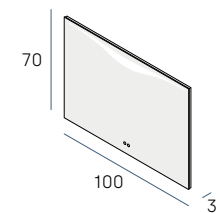

7101

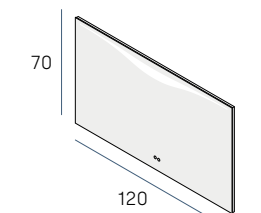

es Colección Clio con conexión directa a red. Cristal de canto recto con 4 mm de espesor. Luz frontal y retroiluminada de 5500 °K. Bastidor de PVC y sistema de fijación regulable y nivelable

ENG Clio collection with direct connection to mains. Straight edges with 4 mm glass thickness. 5500 °K front and backlit light. PVC inner frame with adjustable fixing system.

Sensor Touch/  
Touch sensor



Sensor touch on/off luz, dimmer y antivaho.  
On/off light, dimmer and defogger touch sensor.

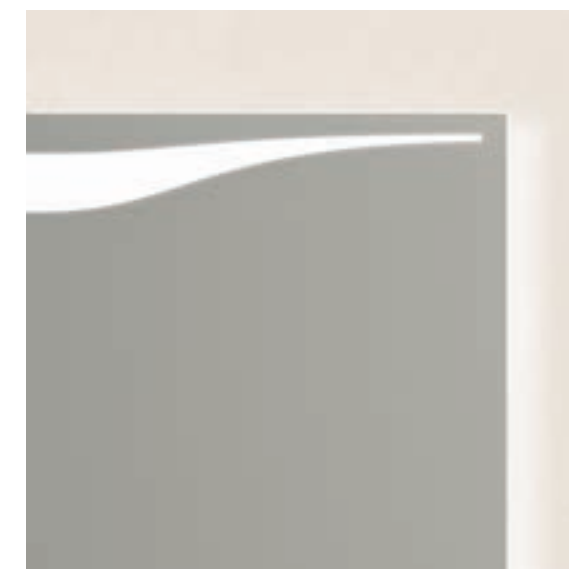

Dimensión/ Dimension	Ref/ Ref	On/Off Luz On/Off Light	Regulación Luz/ Dimmer	Antivaho/ Defogger	T.º de Luz/ Light Temp.	Lumens/ Lumens	Potencia/ Power
80 x 80	7099	✓	✓	✓	5500 °K	2272 Lm	23 W
100 x 70	7100	✓	✓	✓	5500 °K	2432 Lm	24 W
120 x 70	7101	✓	✓	✓	5500 °K	2752 Lm	28 W

# stripe

LUZ FRONTAL  
FRONTAL LIGHT

7142/7279

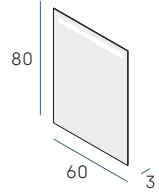

7143/7280

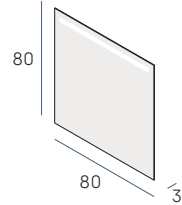

7144/7281

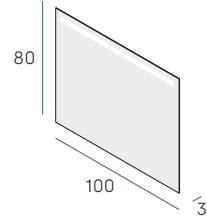

7145/7282

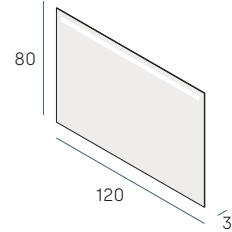

es Colección Stripe con conexión directa a red. Cristal de canto recto con 4 mm de espesor y arenado de 35 mm. Luz frontal de 5500 °K. Bastidor de PVC con sistema de fijación regulable y nivelable.

ENG Stripe collection with direct connection to mains. Straight edges with 4 mm glass thickness and 35 mm sandblasting area. 5500 °K front light. PVC inner frame with adjustable fixing system.

• Versión Plus/  
Plus Version



Incluye sensor touch on/off luz, antivaho y dimmer.  
Includes on/off light, defogger and dimmer touch sensor.

Dimensión/ Dimension	Ref/ Ref	On/Off Luz On/Off Light	Regulación Luz/ Dimmer	Antivaho/ Defogger	T.º de Luz/ Light Temp.	Lumens/ Lumens	Potencia/ Power
60 x 80	7142	-	-	-	5500 °K	416 Lm	4 W
	• 7279	✓	✓	✓			
80 x 80	7143	-	-	-	5500 °K	588 Lm	6 W
	• 7280	✓	✓	✓			
100 x 80	7144	-	-	-	5500 °K	736 Lm	7 W
	• 7281	✓	✓	✓			
120 x 80	7145	-	-	-	5500 °K	896 Lm	9 W
	• 7282	✓	✓	✓			



# line

## LUZ FRONTAL FRONTAL LIGHT

es Colección Line con conexión directa a red. Cristal de canto recto con 4 mm de espesor y arenado de 35 mm. Luz frontal de 5500 °K. Bastidor de PVC con sistema de fijación regulable y nivelable y marco exterior de aluminio.

ENG Line collection with direct connection to mains. Straight edges with 4 mm glass thickness and 35 mm sandblasting area. 5500 °K front light. PVC inner frame with adjustable and leveling fixing system and aluminum outer frame.

- Versión Plus/  
Plus Version



Incluye sensor touch on/off luz, antivaho y dimmer.  
Includes on/off light, defogger and dimmer touch sensor.



7147/7284

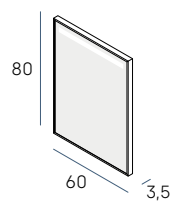

7148/7285

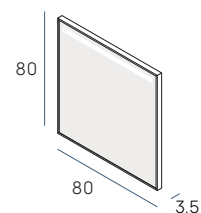

7149/7286

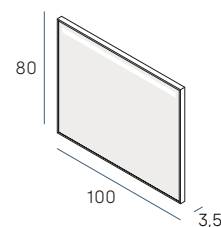

7150/7287

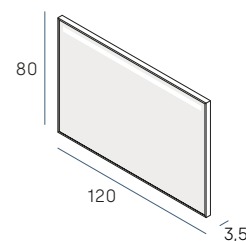

Dimensión/ Dimension	Ref/ Ref	On/Off Luz/ On/Off Light	Regulación Luz/ Dimmer	Antivaho/ Defogger	T.º de Luz/ Light Temp.	Lumens/ Lumens	Potencia/ Power
60 x 80	7147	-	-	-	5500 °K	416 Lm	4 W
	• 7284	✓	✓	✓			
80 x 80	7148	-	-	-	5500 °K	588 Lm	6 W
	• 7285	✓	✓	✓			
100 x 80	7149	-	-	-	5500 °K	736 Lm	7 W
	• 7286	✓	✓	✓			
120 x 80	7150	-	-	-	5500 °K	896 Lm	9 W
	• 7287	✓	✓	✓			

### Acabados/ Finishes



012 Inox. Cepillado / Brushed St. Steel  
021 Oro Cepillado / Brushed Gold  
081 Negro Mate / Matt Black  
034 Terracota / Terracotta  
032 Verde Reseda / Reseda Green  
040 Azul Atlántico / Atlantic Blue  
075 Blanco Mate / Matt White







# marcus

## LUZ FRONTAL Y PERIMETRAL FRONTAL AND PERIMETRAL LIGHT

7152/7289

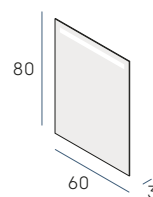

7153/7290

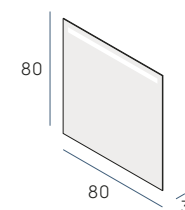

7154/7291

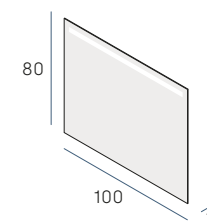

7155/7292

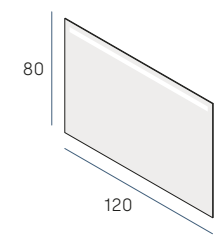

es Colección Marcus con conexión directa a red. Cristal de canto recto con 4 mm de espesor y arenado de 35 mm. Luz frontal y perimetral de 5500 °K. Bastidor de PVC con sistema de fijación regulable y nivelable.

ene Marcus collection with direct connection to mains. Straight edges with 4 mm glass thickness and 35 mm sandblasting area. 5500 °K front and perimetral light. PVC inner frame with adjustable fixing system.

• Versión Plus/  
Plus Version



Incluye sensor touch on/off luz, antivaho y dimmer.  
Includes on/off light, defogger and dimmer touch sensor.

Dimensión/ Dimension	Ref/ Ref	On/Off Luz On/Off Light	Regulación Luz/ Dimmer	Antivaho/ Defogger	T.º de Luz/ Light Temp.	Lumens/ Lumens	Potencia/ Power
60 x 80	7152	-	-	-	5500 °K	2352 Lm	20 W
	• 7289	✓	✓	✓			
80 x 80	7153	-	-	-	5500 °K	2432 Lm	24 W
	• 7290	✓	✓	✓			
100 x 80	7154	-	-	-	5500 °K	2512 Lm	25 W
	• 7291	✓	✓	✓			
120 x 80	7155	-	-	-	5500 °K	2832 Lm	28 W
	• 7292	✓	✓	✓			

Sobre pedido  
Upon request

Cambio de temperatura de luz: 3000 °K o 4200 °K  
Change of light temperature: 3000 °K or 4200 °K

# lexus

LUZ FRONTAL  
FRONTAL LIGHT

7081/7275

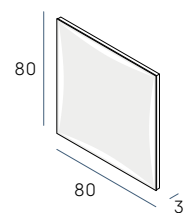

7082/7276

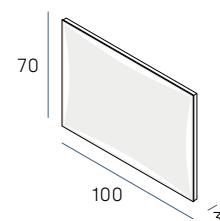

7083/7277

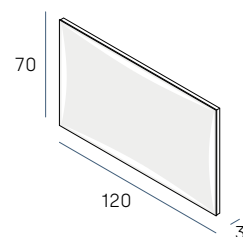

7084/7278

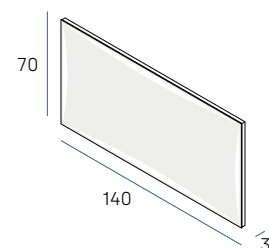

es Colección Lexus con conexión directa red. Cristal de canto recto con 4 mm de espesor. Luz frontal de 5500 °K. Bastidor de PVC con sistema de fijación regulable y nivelable.

ENG Lexus collection with direct connection to mains. Straight edges with 4 mm glass thickness. 5500 °K front light. PVC inner frame with adjustable fixing system.

• Versión Plus/  
Plus Version



Incluye sensor touch on/off antivaho.  
Includes on/off defogger touch sensor.

Dimensión/ Dimension	Ref/ Ref	On/Off Antivaho/ On/Off Defogger	T.º de Luz/ Light Temp.	Lumens/ Lumens	Potencia/ Power
80 x 80	7081	-	5500 °K	2112 Lm	21 W
	• 7275	✓			
100 x 70	7082	-	5500 °K	2432 Lm	23 W
	• 7276	✓			
120 x 70	7083	-	5500 °K	2592 Lm	26 W
	• 7277	✓			
140 x 70	7084	-	5500 °K	2912 Lm	29 W
	• 7278	✓			

Sobre pedido  
Upon request

Cambio de temperatura de luz: 3000 °K o 4200 °K  
Change of light temperature: 3000 °K or 4200 °K



De las cuatro líneas rectas y con un pequeño gesto, se redondean las esquinas, dando como resultado un espejo más amable y cercano. Un redondeo sutil que genera una nueva tipología de espejos dentro de nuestras colecciones.

Out of the four straight lines and with a small gesture, the corners are rounded, resulting in a friendly and welcoming mirror. A subtle rounding that generates a new typology of mirrors within our collections.

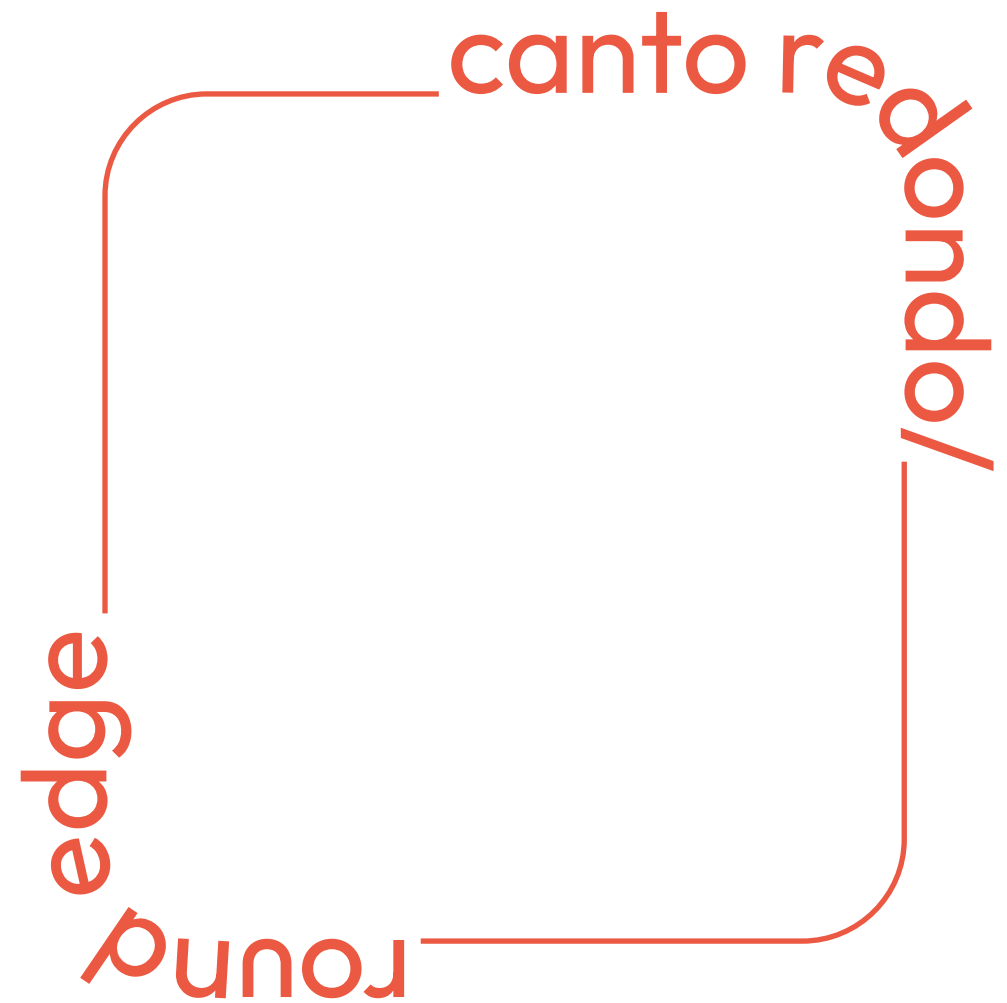

green

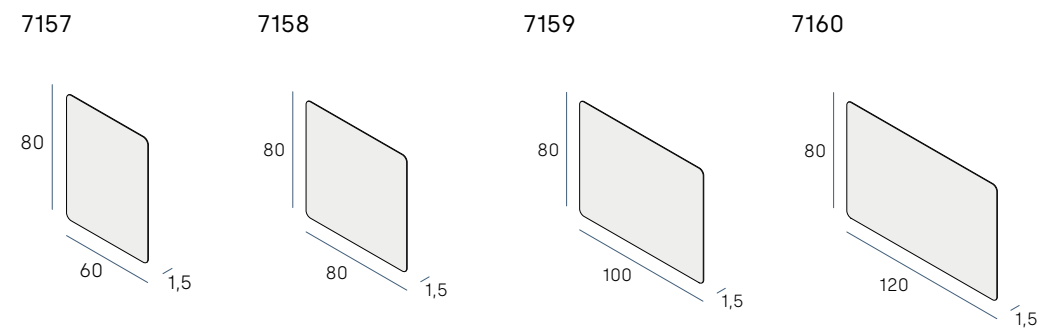

es Colección Green. Cristal de canto redondo con 4 mm de espesor. Fijación mediante pletinas metálicas.

ENG Green collection. Rounded edges with 4 mm glass thickness. Fixing metal plates.

Dimensión/ Dimension	Referencia Reference	Vertical/Horizontal
60 x 80	7157	✓
80 x 80	7158	V
100 x 80	7159	✓
120 x 80	7160	H





# brisa

LUZ RETROILUMINADA  
BACKLIT LIGHT

7167/7294

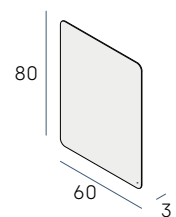

7168/7295

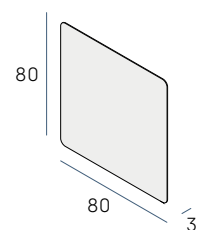

7169/7296

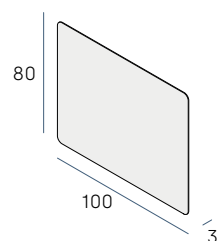

7170/7297

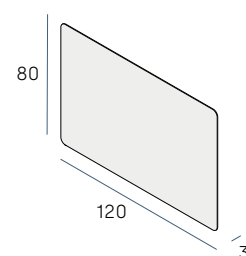

es Colección Brisa con conexión directa a red. Cristal de canto redondo de 4 mm de espesor. Luz retroiluminada de 5500 °K. Bastidor de PVC con sistema de fijación regulable y nivelable.

ENE Brisa collection with direct connection to mains. Rounded edges with 4 mm glass thickness. 5500 °K backlit light. PVC inner frame with adjustable fixing system.

• Versión Plus/  
Plus Version



Incluye sensor touch: on/off luz, antivaho y dimmer.

Includes on/off light, defogger and dimmer touch sensor.

Dimensión/ Dimension	Ref/ Ref	On/Off Luz On/Off Light	Regulación Luz/ Dimmer	Antivaho/ Defogger	T.º de Luz/ Light Temp.	Lumens/ Lumens	Potencia/ Power
60 x 80	7167	-	-	-	5500°K	1920 Lm	19 W
	• 7294	✓	✓	✓			
80 x 80	7168	-	-	-	5500°K	2240 Lm	22 W
	• 7295	✓	✓	✓			
100 x 80	7169	-	-	-	5500°K	2560 Lm	26 W
	• 7296	✓	✓	✓			
120 x 80	7170	-	-	-	5500°K	2880 Lm	29 W
	• 7297	✓	✓	✓			

Sobre pedido  
Upon request

Cambio de temperatura de luz: 3000 °K o 4200 °K  
Change of light temperature: 3000 °K or 4200 °K



Versión Plus/  
Plus Version



## ona

### LUZ FRONTAL Y RETROILUMINADA FRONTAL AND BACKLIT LIGHT

7172/7299

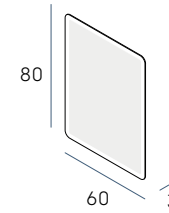

7173/7300

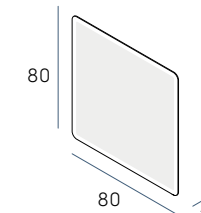

7174/7301

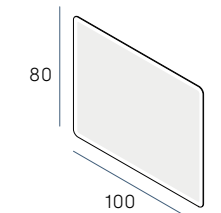

7175/7302

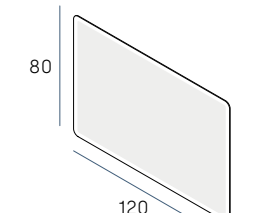

ES Colección Ona con conexión directa a red. Cristal de canto redondo de 4 mm de espesor y arenado de 30 mm. Luz frontal y retroiluminada de 5500 °K. Bastidor de PVC con sistema de fijación regulable y nivelable.

ENG Ona collection with direct connection to mains. Rounded edges with 4 mm glass thickness and 30 mm sandblasting area. 5500 °K front and backlit light. PVC inner frame with adjustable fixing system.

• Versión Plus/  
Plus Version



Incluye sensor touch on/off luz, antivaho y dimmer.  
Includes on/off light, defogger and dimmer touch sensor.

Dimensión/ Dimension	Ref/ Ref	On/Off Luz/ On/Off Light	Regulación Luz/ Dimmer	Antivaho/ Defogger	T.º de Luz/ Light Temp.	Lumens/ Lumens	Potencia/ Power
60 x 80	7172	-	-	-	5500°K	1920 Lm	19 W
	• 7299	✓	✓	✓			
80 x 80	7173	-	-	-	5500°K	2240 Lm	22 W
	• 7300	✓	✓	✓			
100 x 80	7174	-	-	-	5500°K	2560 Lm	26 W
	• 7301	✓	✓	✓			
120 x 80	7175	-	-	-	5500°K	2880 Lm	29 W
	• 7302	✓	✓	✓			

Sobre pedido  
Upon request

Cambio de temperatura de luz: 3000 °K o 4200 °K  
Change of light temperature: 3000 °K or 4200 °K

**ondra**

**LUZ FRONTAL Y PERIMETRAL  
FRONTAL AND BACKLIT LIGHT**

es Colección Ondra con conexión directa a red. Cristal de canto redondo con 4 mm de espesor y arenado de 33 mm. Con luz frontal y perimetral de 5500 °K y bastidor de PVC con sistema de fijación regulable y nivelable

eng Ondra collection with direct connection to mains. Rounded edges with 4 mm glass thickness and 33 mm sandblasting area. 5500 °K front and backlit light. PVC inner frame with adjustable fixing system.

• Versión Plus/  
Plus Version



Incluye sensor touch on/off luz, antivaho y dimmer.  
Includes on/off light, defogger and dimmer touch sensor.



7182/7309

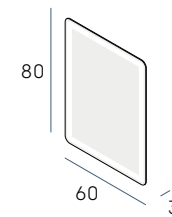

7183/7310

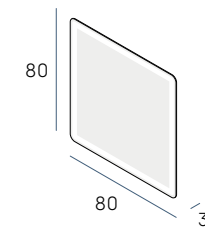

7184/7311

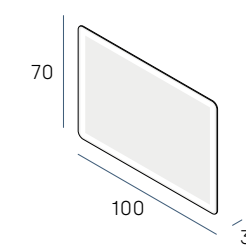

7185/7312

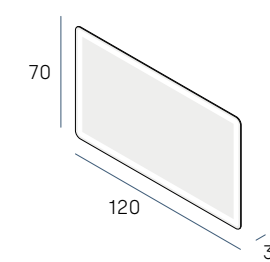

7186/7313

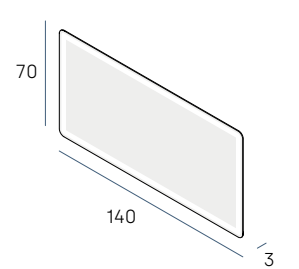

Dimensión/ Dimension	Ref/ Ref	On/Off Luz/ On/Off Light	Regulación Luz/ Dimmer	Antivaho/ Defogger	T.º de Luz/ Light Temp.	Lumens/ Lumens	Potencia/ Power
60 x 80	7182	-	-	-	5500°K	1792 Lm	18 W
	• 7309	✓	✓	✓			
80 x 80	7183	-	-	-	5500°K	2112 Lm	21 W
	• 7310	✓	✓	✓			
100 x 70	7184	-	-	-	5500°K	2272 Lm	23 W
	• 7311	✓	✓	✓			
120 x 70	7185	-	-	-	5500°K	2592 Lm	26 W
	• 7312	✓	✓	✓			
140 x 70	7186	-	-	-	5500°K	2912 Lm	29 W
	• 7313	✓	✓	✓			

Sobre pedido  
Upon request

Cambio de temperatura de luz: 3000 °K o 4200 °K  
Change of light temperature: 3000 °K or 4200 °K

Versión Plus/  
Plus Version

# ondra vestidor

LUZ FRONTAL Y PERIMETRAL  
FRONTAL AND BACKLIT LIGHT

7187/7314

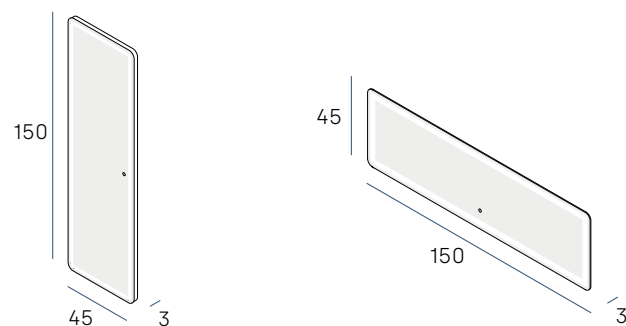

es Espejo Ondra Vestidor con conexión directa a red. Cristal de canto redondo con 4 mm de espesor y arenado de 33 mm. Luz frontal y perimetral de 5500 °K y bastidor de PVC con sistema de fijación regulable y nivelable.

ENG Ondra Vestidor Mirror with direct connection to mains. Rounded edges with 4 mm glass thickness and 33 mm sandblasting area. 5500 °K front and backlit light. PVC inner frame with adjustable fixing system.

• Versión Plus/  
Plus Version



Incluye sensor touch on/off luz, antivaho y dimmer.  
Includes on/off light, defogger and dimmer touch sensor.

Dimensión/ Dimension	Ref/ Ref	On/Off Luz/ On/Off Light	Regulación Luz/ Dimmer	Antivaho/ Defogger	T.º de Luz/ Light Temp.	Lumens/ Lumens	Potencia/ Power	Posición/ Position
150 x 45	7187	✓	-	-	5500°K	2736	27 W	V/H
	• 7314	✓	✓	✓				

Sobre pedido  
Upon request

Cambio de temperatura de luz: 3000 °K o 4200 °K  
Change of light temperature: 3000 °K or 4200 °K



Versión Plus/  
Plus Version



nao

LUZ FRONTAL  
FRONTAL LIGHT

es Colección Nao con conexión directa a red. Cristal de canto redondo de 4 mm de espesor y arenado de 33 mm con film antiexplosión. Luz frontal regulable de 3000 °K a 6500 °K y marco exterior de aluminio.

ENG Nao collection with direct connection to mains. Rounded edges with 4 mm glass thickness and 33 mm sand-blasting area with anti scattering film. Front dimmable light from 3000 °K to 6500 °K with aluminium outer frame.

Sensor touch/  
Touch sensor



Sensor touch on/off luz, antivaho y dimmer.  
On/off light, defogger and dimmer touch sensor.

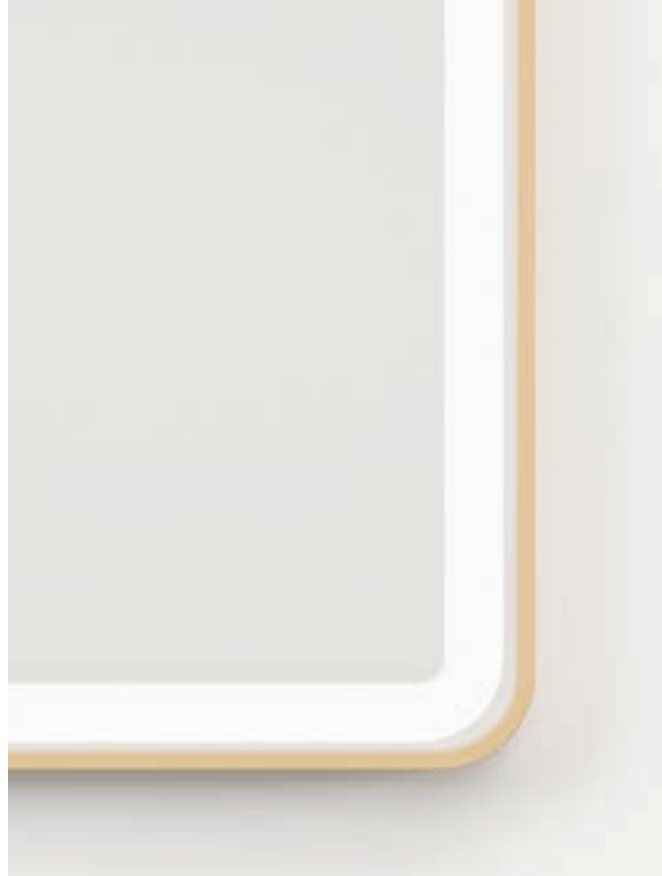

7304

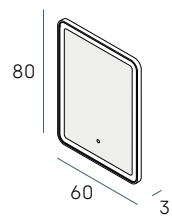

7305

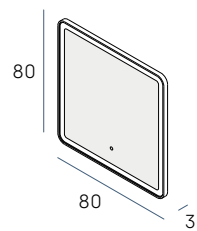

7306

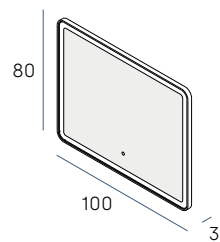

7307

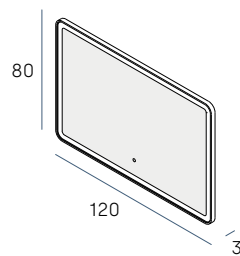

Dimensión/ Dimension	Ref/ Ref	On/Off Luz/ On/Off Light	Regulación Luz/ Dimmer	Antivaho/ Defogger	T.º de Luz/ Light Temp.	Lumens/ Lumens	Potencia/ Power
60 x 80	7304	✓	✓	✓	3000 °K 6500 °K	2703 Lm	33 W
80 x 80	7305	✓	✓	✓	3000 °K 6500 °K	3142 Lm	38 W
100 x 80	7306	✓	✓	✓	3000 °K 6500 °K	3557 Lm	43 W
120 x 80	7307	✓	✓	✓	3000 °K 6500 °K	4019 Lm	49 W

Acabados/  
Finishes



Oro Cepillado  
Brushed Gold



Negro Mate  
Matt Black



Rosé Cepillado  
Brushed Rosé

# vitara

## LUZ FRONTAL FRONTAL LIGHT

ES Colección Vitara con conexión directa a red. Cristal de canto redondo con 4 mm de espesor y arenado de 33 mm. Con luz frontal de 5500 °K, sensor antivaho y bastidor de PVC con sistema de fijación regulable y nivelable.

ENG Vitara collection with direct connection to mains. Rounded edges with 4 mm glass thickness and 33 mm sand-blasting area. 5500 °K front light and defogger sensor. PVC inner frame with adjustable fixing system.

• Versión Plus/  
Plus Version



Incluye dos tipos de luz (4200-5500 °K) y sensores touch on/off luz y antivaho.

Includes two types of light (4200-5500 °K) and on/off light and defogger touch sensors.

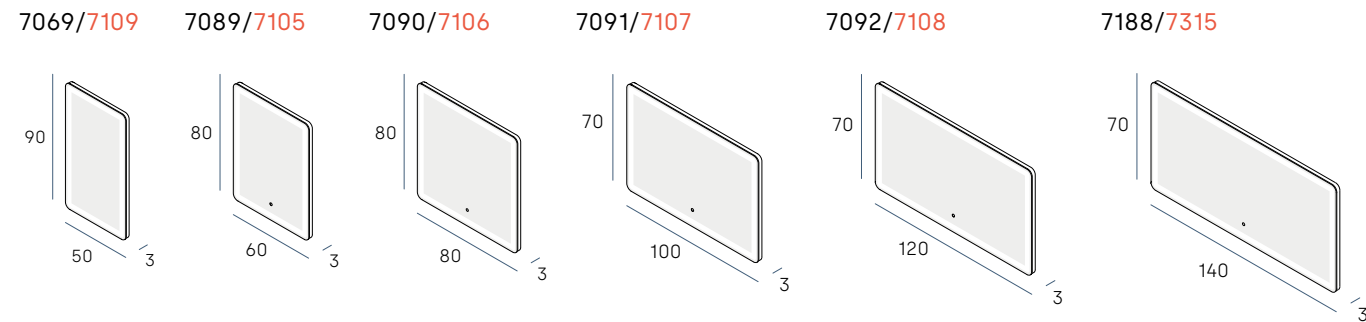

Dimensión/ Dimension	Ref/ Ref	On/Off Luz/ On/Off Light	Antivaho/ Defogger	T.º de Luz/ Light Temp.	Lumens/ Lumens	Potencia/ Power
50 x 90	7069	-	✓	5500°K	1920 Lm	19 W
	• 7109	✓	✓	4200°K 5500°K		
60 x 80	7089	-	✓	5500°K	1920 Lm	19 W
	• 7105	✓	✓	4200°K 5500°K		
80 x 80	7090	-	✓	5500°K	2112 Lm	21 W
	• 7106	✓	✓	4200°K 5500°K		
100 x 70	7091	-	✓	5500°K	2272 Lm	23 W
	• 7107	✓	✓	4200°K 5500°K		
120 x 70	7092	-	✓	5500°K	2592 Lm	26 W
	• 7108	✓	✓	4200°K 5500°K		
140 x 70	7188	-	✓	5500°K	2912 Lm	29 W
	• 7315	✓	✓	4200°K 5500°K		

Sobre pedido  
Upon request

Cambio de temperatura de luz en su versión básica: 3000 °K o 4200 °K  
Change of light temperature in its basic version: 3000 °K or 4200 °K



Versión Plus/  
Plus Version

# vitara vestidor

LUZ FRONTAL  
FRONTAL LIGHT

7093/7316

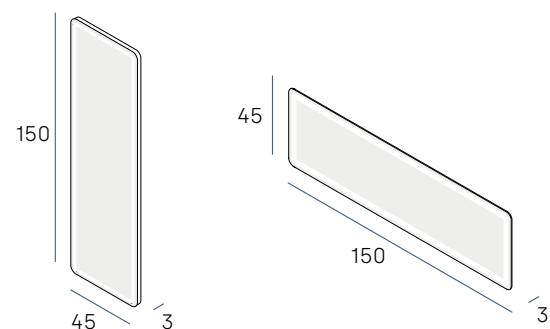

es Espejo Vitara Vestidor con conexión directa a red. Cristal de canto redondo con 4 mm de espesor y arenado de 33 mm. Luz frontal de 5500 °K y bastidor de PVC con sistema de fijación regulable y nivelable.

ENG Vitara Vestidor mirror with direct connection to mains. Rounded edges with 4 mm glass thickness and 33 mm sandblasting area. 5500 °K front light. PVC inner frame with adjustable fixing system.

• Versión Plus/  
Plus Version



Incluye sensor touch on/off luz, antivaho y dimmer.  
Includes on/off light, defogger and dimmer touch sensor.

Dimensión/ Dimension	Ref/ Ref	On/Off Luz/ On/Off Light	Regulación Luz/ Dimmer	Antivaho/ Defogger	T.º de Luz/ Light Temp.	Lumens/ Lumens	Potencia/ Power	Posición/ Position
150 x 45	7093	✓	-	-	5500°K	2736 Lm	27 W	V/H
	• 7316	✓	✓	✓				

Sobre pedido  
Upon request

Cambio de temperatura de luz: 3000 °K o 4200 °K  
Change of light temperature: 3000 °K or 4200 °K



Versión Plus/  
Plus Version



# tango

## LUZ INTEGRADA INTEGRATED LIGHT

es Colección Tango con conexión directa a red. Cristal de canto redondo con 4 mm de espesor. Con luz integrada regulable de 3000 °K a 6500 °K y marco exterior de aluminio.

eng Tango collection with direct connection to mains. Rounded edges with 4 mm glass thickness. With integrated dimmable light from 3000 °K to 6500 °K and aluminum outer frame.

Sensores touch/  
Touch sensors



Sensor touch on/off luz, antivaho, dimmer y reloj.  
On/off light, defogger and dimmer touch sensor and clock.

7367

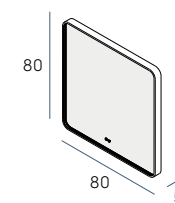

7368

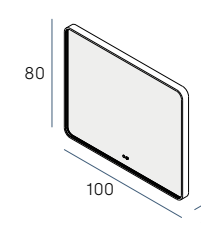

7369

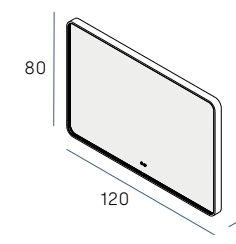

7370

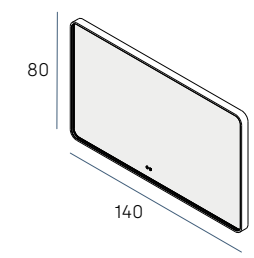

Dimensión/ Dimension	Ref/ Ref	On/Off Luz/ On/Off Light	Regulación Luz/ Dimmer	Antivaho/ Defogger	T.º de Luz/ Light Temp.	Lumens/ Lumens	Potencia/ Power
80 x 80	7367	✓	✓	✓	3000 °K 6500 °K	1894 Lm	20 W
100 x 80	7368	✓	✓	✓	3000 °K 6500 °K	2132 Lm	22 W
120 x 80	7369	✓	✓	✓	3000 °K 6500 °K	2368 Lm	24 W
140 x 80	7370	✓	✓	✓	3000 °K 6500 °K	2605 Lm	27 W

Acabados/  
Finishes



021  
Oro Cepillado  
Brushed Gold



081  
Negro Mate  
Matt Black



047  
Bronce Cepillado  
Brushed Bronze



Ampliando el gesto, aparece el círculo, como sinónimo de lo infinito, la adaptabilidad y la unión. Aportando una amplia gama de espejos circulares dispuestos a adaptarse y completar cada espacio.

Expanding the gesture, the circle appears, as a synonym of infinity, adaptability and union. Providing a wide range of mirrors ready to adapt and complete each space.

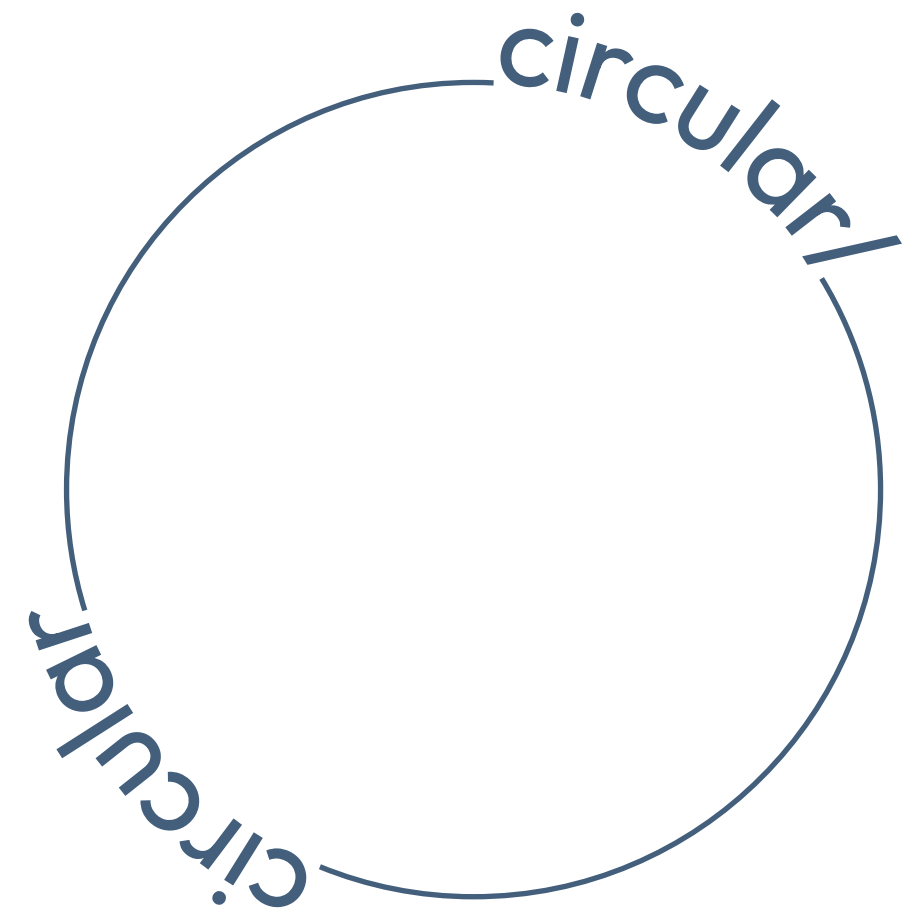

# alvero

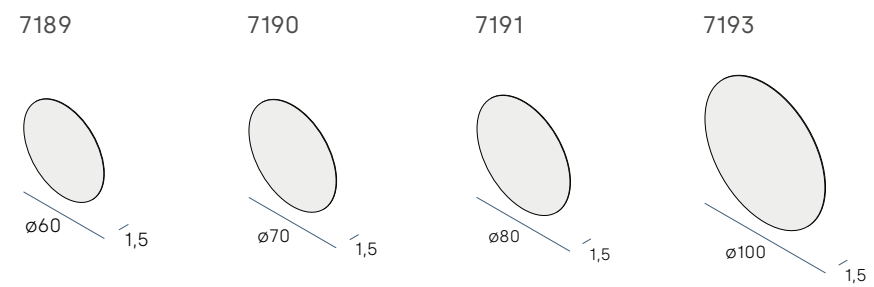

es Colección Alvero. Cristal circular de 4 mm de espesor. Fijación mediante pletinas metálicas.

ENG Alvero collection. Circle shape mirror with 4 mm glass thickness. Fixing metal plates.

Dimensión/ Dimension	Referencia/ Reference
Ø 60	7189
Ø 70	7190
Ø 80	7191
Ø 100	7193





# alba



ES Colección Alba. Cristal circular de 4 mm de espesor. Marco exterior de aluminio.

ENG Alba collection. Circle shape mirror with 4 mm glass thickness. Aluminium outer frame.

7195

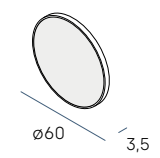

7196

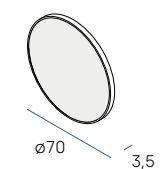

7197

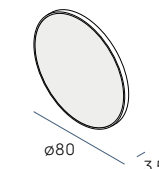

7199

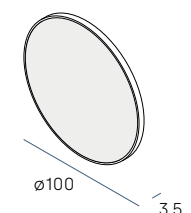

Dimensión/ Dimension	Referencia/ Reference
Ø 60	7195
Ø 70	7196
Ø 80	7197
Ø 100	7199

### Acabados/ Finishes

- 021  
 Oro Cepillado  
 Brushed Gold
- 012  
 Inox. Cepillado  
 Brushed St. Steel
- 081  
 Negro Mate  
 Matt Black
- 034  
 Terracota  
 Terracotta
- 032  
 Verde Reseda  
 Reseda Green
- 040  
 Azul Atlántico  
 Atlantic Blue
- 075  
 Blanco Mate  
 Matt White

# bruma

## LUZ RETROILUMINADA BACKLIT LIGHT

7201/7317

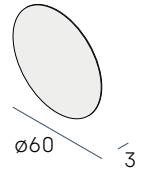

7202/7318

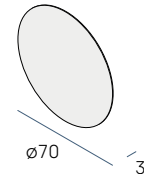

7203/7319

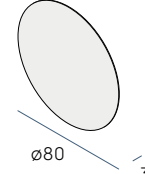

7205/7321

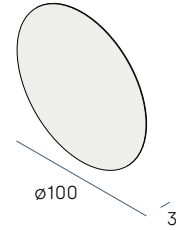

es Colección Bruma con conexión directa a red. Cristal circular de 4 mm de espesor. Luz retroiluminada de 5500 °K. Bastidor de goma EVA.

ENG Bruma collection with direct connection to mains. Circle shape mirror with 4 mm glass thickness. 5500 °K backlit light. EVA foam inner frame

- Versión Plus/  
Plus Version



Incluye sensor touch on/off luz, antivaho y dimmer.  
Bastidor de aluminio con difusor.

Includes touch sensor on/off light, defogger and dimmer.  
Aluminum inner frame with diffuser.

Dimensión/ Dimension	Ref/ Ref	On/Off Luz On/Off Light	Regulación Luz/ Dimmer	Antivaho/ Defogger	T.º de Luz/ Light Temp.	Lumens/ Lumens	Potencia/ Power
Ø 60	7201	-	-	-	5500 °K	1432 Lm	14 W
	• 7317	✓	✓	✓			
Ø 70	7202	-	-	-	5500 °K	1684 Lm	17 W
	• 7318	✓	✓	✓			
Ø 80	7203	-	-	-	5500 °K	1936 Lm	19 W
	• 7319	✓	✓	✓			
Ø 100	7205	-	-	-	5500 °K	2440 Lm	24 W
	• 7321	✓	✓	✓			

Sobre pedido  
Upon request

Cambio de temperatura de luz: 3000 °K o 4200 °K  
Change of light temperature: 3000 °K or 4200 °K





# moon

LUZ RETROILUMINADA  
BACKLIT LIGHT

7207/7323

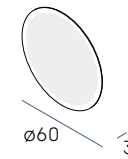

7208/7324

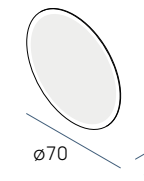

7209/7325

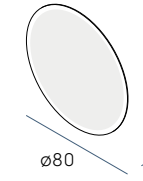

ES Colección Moon con conexión directa a red. Cristal circular de 4 mm de espesor y arenado de 30 mm. Luz retroiluminada de 5500 °K. Bastidor de goma EVA.

ENG Moon collection with direct connection to mains. Circle shape mirror with 4 mm glass thickness and 30 mm sandblasting area. 5500 °K backlit light. EVA foam inner frame.

• Versión Plus/  
Plus Version



Incluye sensor touch on/off luz, antivaho y dimmer.  
Bastidor de aluminio con difusor.

Includes touch sensor on/off light, defogger and dimmer.  
Aluminum inner frame with diffuser.

Dimensión/ Dimension	Ref/ Ref	On/Off Luz On/Off Light	Regulación Luz/ Dimmer	Antivaho/ Defogger	T.º de Luz/ Light Temp.	Lumens/ Lumens	Potencia/ Power
Ø 60	7207	-	-	-	5500 °K	1284 Lm	13 W
	• 7323	✓	✓	✓			
Ø 70	7208	-	-	-	5500 °K	1533 Lm	15 W
	• 7324	✓	✓	✓			
Ø 80	7209	-	-	-	5500 °K	1784 Lm	18 W
	• 7325	✓	✓	✓			

Sobre pedido  
Upon request

Cambio de temperatura de luz: 3000 °K o 4200 °K  
Change of light temperature: 3000 °K or 4200 °K

# sun

## LUZ FRONTAL FRONTAL LIGHT

es Espejo Sun con conexión directa a red. Cristal circular de 4 mm de espesor y arenado de 35 mm con film anti-explósión. Luz frontal regulable de 3000 °K a 6500 °K. Marco exterior de aluminio. Protección IP65.

ENG Sun collection with direct connection to mains. Circle shape mirror with 4 mm glass thickness and 35 mm sandblasting area with anti scattering film. 3000 °K to 6500 °K dimmable front light. Aluminium outer frame. IP65 protection.

Sensor touch/  
Touch sensor



Sensor touch on/off luz, antivaho y dimmer.  
Touch sensor on/off light, defogger and dimmer.

7331

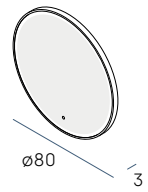

7333

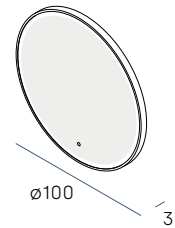

Dimensión/ Dimension	Ref/ Ref	On/Off Luz On/Off Light	Regulación Luz/ Dimmer	Antivaho/ Defogger	T.º de Luz/ Light Temp.	Lumens/ Lumens	Potencia/ Power
Ø 80	7331	✓	✓	✓	3000 °K 6500 °K	2541 Lm	31 W
Ø 100	7333	✓	✓	✓	3000 °K 6500 °K	3234 Lm	40 W

Acabados/  
Finishes



Oro Cepillado  
Brushed Gold



Negro Mate  
Matt Black



Rosé Cepillado  
Brushed Rosé

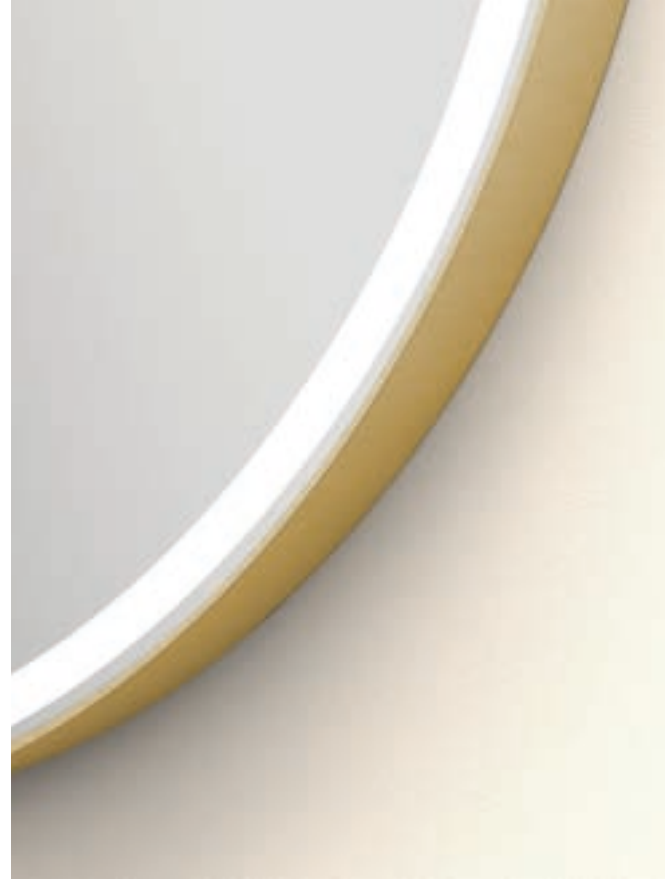





# redondo

LUZ FRONTAL  
FRONTAL LIGHT

7074/7110

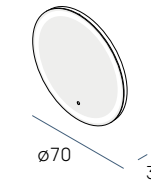

7075/7111

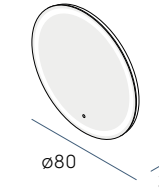

es Colección Redondo con conexión directa a red. Cristal circular de 4 mm de espesor y arenado de 35 mm. Con luz frontal de 5500 °K, sensor on/off antivaho y bastidor de PVC.

ENG Redondo collection with direct connection to mains. Circle shape mirror with 4 mm glass thickness and 35 mm sandblasting area. 5500 °K front light and defogger sensor. PVC inner frame.

• Versión Plus/  
Plus Version



Incluye dos tipos de luz (4200-5500 °K) y sensores touch on/off luz y antivaho.

Includes two types of light (4200-5500 °K) and on/off light and defogger touch sensors.

Dimensión/ Dimension	Ref/ Ref	On/Off Luz On/Off Light	Antivaho/ Defogger	T.º de Luz/ Light Temp.	Lumens/ Lumens	Potencia/ Power
Ø 70	7074	✓	✓	5500 °K	1800 Lm	17 W
	• 7110	✓	✓	4200°K 5500 °K		
Ø 80	7075	✓	✓	5500 °K	2100 Lm	19 W
	• 7111	✓	✓	4200°K 5500 °K		

Sobre pedido  
Upon request

Cambio de temperatura de luz en su versión básica: 3000 °K o 4200 °K  
Change of light temperature in its basic version: 3000 °K or 4200 °K

# arena

LUZ FRONTAL Y RETROILUMINADA  
FRONTAL AND BACKLIT LIGHT

7220/7336

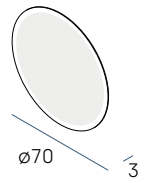

7221/7337

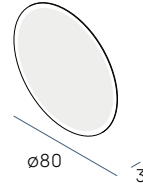

7223/7339

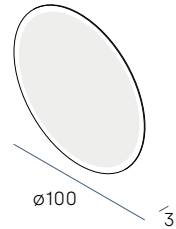

es Colección Arena con conexión directa a red. Cristal circular de 4 mm de espesor y arenado de 35 mm. Luz frontal y retroiluminada de 5500 °K. Bastidor de goma EVA.

ENG Arena collection with direct connection to mains. Circle shape mirror with 4 mm glass thickness and 35 mm sandblasting area. 5500 °K front and backlit light. EVA foam inner frame.

- Versión Plus/  
Plus Version



Incluye sensor touch on/off luz, antivaho y dimmer.  
Bastidor de aluminio con difusor.

Includes on/off light, defogger and dimmer touch sensor.  
Aluminum inner frame with diffuser.

Dimensión/ Dimension	Ref/ Ref	On/Off Luz On/Off Light	Regulación Luz/ Dimmer	Antivaho/ Defogger	T.º de Luz/ Light Temp.	Lumens/ Lumens	Potencia/ Power
Ø 70	7220	-	-	-	5500 °K	1428 Lm	14 W
	• 7336	✓	✓	✓			
Ø 80	7221	-	-	-	5500 °K	1608 Lm	16 W
	• 7337	✓	✓	✓			
Ø 100	7223	-	-	-	5500 °K	2182 Lm	22 W
	• 7339	✓	✓	✓			

Sobre pedido  
Upon request

Cambio de temperatura de luz: 3000 °K o 4200 °K  
Change of light temperature: 3000 °K or 4200 °K





# circular

LUZ FRONTAL  
FRONTAL LIGHT

7342/7226

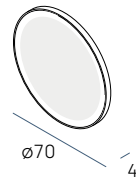

7343/7076

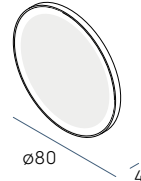

es Colección Circular con conexión directa a red. Cristal circular de 4 mm de espesor y arenado de 40 mm. Luz frontal de 5500 °K. Marco exterior de aluminio.

ENG Circular collection with direct connection to mains. Circle shape mirror with 4 mm glass thickness and 40 mm sandblasting area. 5500 °K front light. Aluminium outer frame.

• Versión Plus/  
Plus Version



Incluye sensor touch on/off antivaho.  
Includes on/off defogger touch sensor.



Dimensión/ Dimension	Ref/ Ref	On/Off Antivaho/ On/Off Defogger	T.º de Luz/ Light Temp.	Lumens/ Lumens	Potencia/ Power
Ø 70	7342	-	5500 °K	1428 Lm	14 W
	• 7226	✓			
Ø 80	7343	-	5500 °K	1608 Lm	16 W
	• 7076	✓			

Acabados/  
Finishes



Oro Cepillado  
Brushed Gold



Negro Mate  
Matt Black



Terracota  
Terracotta



Verde Reseda  
Reseda Green



Azul Atlántico  
Atlantic Blue



Blanco Mate  
Matt White



Versión Plus/  
Plus Version

# eclipse

LUZ FRONTAL  
FRONTAL LIGHT

7348/7112

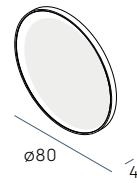

7349/7113

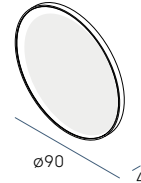

es Colección Eclipse con conexión directa a red. Cristal circular de 4 mm de espesor. Luz frontal de 5500 °K. Marco exterior de aluminio.

ENG Eclipse collection with direct connection to mains. Circle shape mirror with 4 mm glass thickness. 5500 °K front light. Aluminium outer frame.

• Versión Plus/  
Plus Version



Incluye sensor touch on/off luz, antivaho y dimmer.  
Includes touch sensors on/off light, defogger and dimmer.



Dimensión/ Dimension	Ref/ Ref	On/Off Luz On/Off Light	Regulación Luz/ Dimmer	Antivaho/ Defogger	T.º de Luz/ Light Temp.	Lumens/ Lumens	Potencia/ Power
Ø 80	7348	-	-	-	5500 °K	1784 Lm	18 W
	• 7112	✓	✓	✓			
Ø 90	7349	-	-	-	5500 °K	2036 Lm	20 W
	• 7113	✓	✓	✓			

Sobre pedido  
Upon request

Cambio de temperatura de luz: 3000 °K o 4200 °K  
Change of light temperature: 3000 °K or 4200 °K

Acabados/  
Finishes



Oro Cepillado  
Brushed Gold



Negro Mate  
Matt Black





# bolero

LUZ INTEGRADA  
INTEGRATED LIGHT

7371

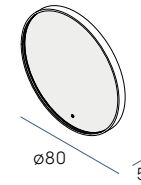

7372

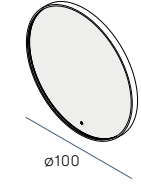

es Colección Bolero con conexión directa a red. Espejo circular con 4 mm de espesor. Luz integrada en el marco regulable de 3000 °K a 6500 °K. Marco exterior de aluminio.

ENG Bolero collection with direct connection to mains. Circle shape mirror with 4 mm glass thickness. With integrated dimmable light from 3000 °K to 6500 °K and aluminum outer frame.

Sensor touch/  
Touch sensor



Sensor touch on/off luz, antivaho y dimmer.  
On/off light, defogger and dimmer touch sensor.

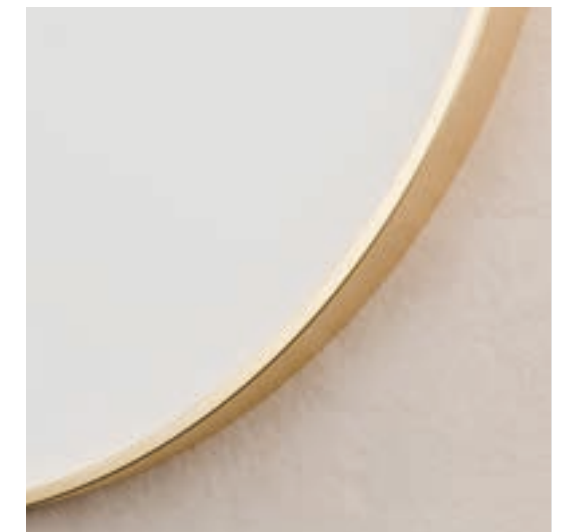

Dimensión/ Dimension	Ref/ Ref	On/Off Luz On/Off Light	Regulación Luz/ Dimmer	Antivaho/ Defogger	T.º de Luz/ Light Temp.	Lumens/ Lumens	Potencia/ Power
Ø 80	7371	✓	✓	✓	3000 °K 6500 °K	2888 Lm	35 W
Ø 100	7372	✓	✓	✓	3000 °K 6500 °K	3600 Lm	44 W

Acabados/  
Finishes



Oro Cepillado  
Brushed Gold



Negro Mate  
Matt Black



Bronce Cepillado  
Brushed Bronze

# hula

## LUZ RETROILUMINADA BACKLIT LIGHT

es Colección Hula con conexión directa a red. Espejo circular con 4 mm de espesor con film antiexplosión. Encendido de luz progresiva de 5500 °K. Posiciones de instalación: izquierda o derecha.

ENG Hula mirror with direct connection to mains. Circle shape mirror with 4 mm glass thickness with anti scattering film. 5500 °K progressive lighting. Installation positions: left or right.

Sensor touch/  
Touch sensor



Sensor touch on/off luz, antivaho y dimmer.

On/off light, defogger and dimmer touch sensor.

7373

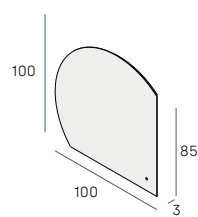

7374

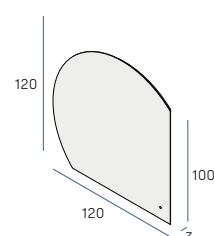

Dimensión/ Dimension	Ref/ Ref	On/Off Luz On/Off Light	Regulación Luz/ Dimmer	Antivaho/ Defogger	T.º de Luz/ Light Temp.	Lumens/ Lumens	Potencia/ Power
100 x 100	7373	✓	✓	✓	5500 °K	1476 Lm	21 W
120 x 120	7374	✓	✓	✓	5500 °K	1810 Lm	26 W





En la intersección entre las líneas rectas y el gesto que las transforma en círculos, aparece la cápsula. La unión de la limpieza y pureza de las líneas rectas a la adaptabilidad y el ritmo de las curvas da origen a nuestra nueva familia de espejos cápsula.

At the intersection between straight lines and the gesture that transforms them into circles, the capsule appears. The combination of the clean and purity of straight lines with the adaptability and rhythm of curves gives rise to our new family of capsule mirrors.

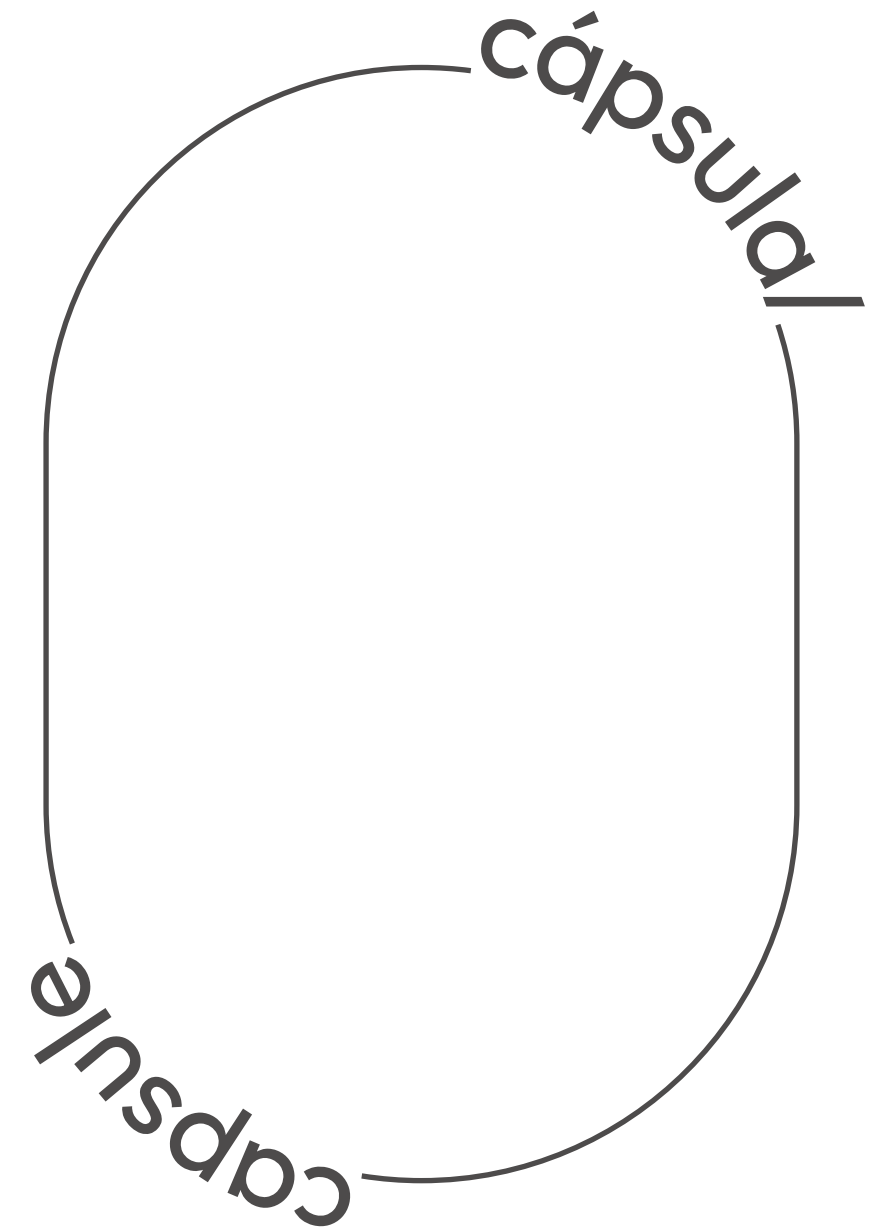

# luk

7230

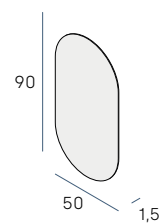

es Espejo Luk. Cristal cápsula de 4 mm de espesor. Fijación mediante pletinas metálicas.

eng Luk Mirror. Capsule glass with 4 mm thickness. Fixing metal plates.

Dimensión/ Dimension	Referencia/ Reference	Vertical/ Vertical
-------------------------	--------------------------	-----------------------

90 x 50	7230	✓
---------	------	---





# aura

LUZ RETROILUMINADA  
BACKLIT LIGHT

7234/7350

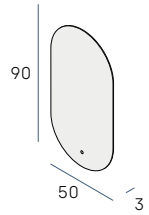

es Espejo Aura con conexión directa a red. Cristal cápsula de 4 mm de espesor. Luz retroiluminada de 5500 °K. Bastidor de goma EVA.

ENG Aura Mirror with direct connection to mains. Capsule glass with 4 mm thickness. 5500 °K backlit light. EVA foam inner frame.

• Versión Plus/  
Plus Version



Incluye sensor touch on/off luz, antivaho y dimmer.  
Bastidor de aluminio con difusor.

Includes on/off light, defogger and dimmer touch  
sensor. Aluminum inner frame with diffuser.

Dimensión/ Dimension	Ref/ Ref	On/Off Luz/ On/Off Light	Regulación Luz/ Dimmer	Antivaho/ Defogger	T.º de Luz/ Light Temp.	Lumens/ Lumens	Potencia/ Power
90 x 50	7234	-	-	-	5500 °K	1750 Lm	18 W
	• 7350	✓	✓	✓			

Sobre pedido  
Upon request

Cambio de temperatura de luz: 3000 °K o 4200 °K  
Change of light temperature: 3000 °K or 4200 °K



Versión Plus/  
Plus Version

# calas

## LUZ RETROILUMINADA BACKLIT LIGHT

ES Colección Calas con conexión directa a red. Cristal cápsula de 4 mm de espesor y arenado de 30 mm. Luz retroiluminada de 5500 °K. Bastidor de goma EVA.

ENG Calas collection with direct connection to mains. Capsule glass with 4 mm thickness and 30 mm sandblasting area. 5500 °K backlit light. EVA foam inner frame.

- Versión Plus/  
Plus Version



Incluye sensor touch on/off luz, antivaho y dimmer. Bastidor de aluminio con difusor.

Includes on/off light, defogger and dimmer touch sensor. Aluminum inner frame with diffuser.

7236/7352

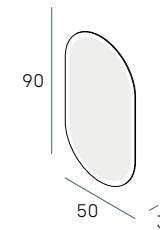

7238/7355

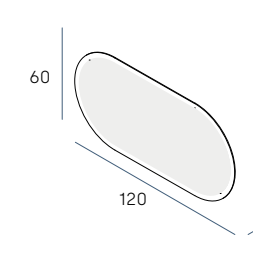

7239/7356

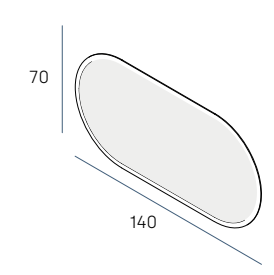

Dimensión/ Dimension	Ref/ Ref	On/Off Luz/ On/Off Light	Regulación Luz/ Dimmer	Antivaho/ Defogger	T.º de Luz/ Light Temp.	Lumens/ Lumens	Potencia/ Power
90 x 50	7236	-	-	-	5500 °K	1625 Lm	16 W
	• 7352	✓	✓	✓			
120 x 60	7238	-	-	-	5500 °K	2242 Lm	22 W
	• 7355	✓	✓	✓			
140 x 70	7239	-	-	-	5500 °K	2653 Lm	27 W
	• 7356	✓	✓	✓			

Sobre pedido  
Upon request

Cambio de temperatura de luz: 3000 °K o 4200 °K  
Change of light temperature: 3000 °K or 4200 °K

# calas vestidor

LUZ RETROILUMINADA  
BACKLIT LIGHT

7098/7357

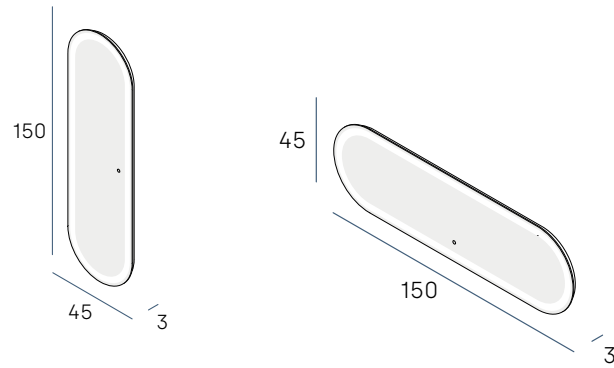

es Espejo Calas Vestidor con conexión directa a red. Cristal cápsula de 4 mm de espesor y arenado de 30 mm. Luz retroiluminada de 5500 °K. Bastidor de goma EVA.

ENG Calas Vestidor mirror with direct connection to mains. Capsule glass with 4 mm thickness and 30 mm sandblasting area. 5500 °K backlit light. EVA foam inner frame.

• Versión Plus/  
Plus Version



Incluye sensor touch on/off luz, antivaho y dimmer. Bastidor de aluminio con difusor.

Includes on/off light, defogger and dimmer touch sensor. Aluminum inner frame with diffuser.

Dimensión/ Dimension	Ref/ Ref	On/Off Luz/ On/Off Light	Regulación Luz/ Dimmer	Antivaho/ Defogger	T.º de Luz/ Light Temp.	Lumens/ Lumens	Potencia/ Power	Posición/ Position
150 x 45	7098	✓	-	-	5500 °K	2585 Lm	26 W	V/H
	• 7357	✓	✓	✓				



Versión Plus/  
Plus Version



Versión Plus/  
Plus Version

## eros

LUZ FRONTAL Y RETROILUMINADA  
FRONTAL AND BACKLIT LIGHT

7245/7246

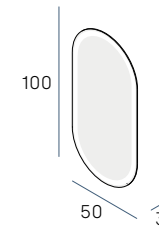

**ES** Espejo Eros con conexión directa a red. Cristal cápsula de 4 mm de espesor y arenado de 25 mm. Luz frontal y retroiluminada de 5500 °K. Bastidor de goma EVA.

**ENG** Eros mirror with direct connection to mains. Capsule glass with 4 mm thickness and 25 mm sandblasting area. 5500 °K frontal and backlit light. EVA foam inner frame.

• Versión Plus/  
Plus Version



Incluye sensor touch on/off luz, antivaho y dimmer. Bastidor de aluminio con difusor.

Includes on/off light, defogger and dimmer touch sensor. Aluminum inner frame with diffuser.



Dimensión/ Dimension	Ref/ Ref	On/Off Luz/ On/Off Light	Regulación Luz/ Dimmer	Antivaho/ Defogger	T.º de Luz/ Light Temp.	Lumens/ Lumens	Potencia/ Power
100 x 50	7245	-	-	-	5500 °K	1800 Lm	18 W
	• 7246	✓	✓	✓			
Sobre pedido Upon request					Cambio de temperatura de luz: 3000 °K o 4200 °K Change of light temperature: 3000 °K or 4200 °K		



# dante

LUZ FRONTAL  
FRONTAL LIGHT

es Espejo Dante con conexión directa a red. Cristal cápsula de 4 mm de espesor y arenado de 30 mm con film antiexplosión. Luz frontal regulable de 3000 a 6500 °K. Marco exterior de aluminio.

ENG Dante mirror with direct connection to mains. Capsule glass with 4 mm thickness and 30 mm sandblasting area with anti scattering film. Dimmable front light from 3000 °K to 6500 °K. Aluminium outer frame.

Sensor Touch/  
Touch Sensor



Sensor touch on/off luz, antivaho y dimmer.  
On/off light, defogger and dimmer touch sensor.

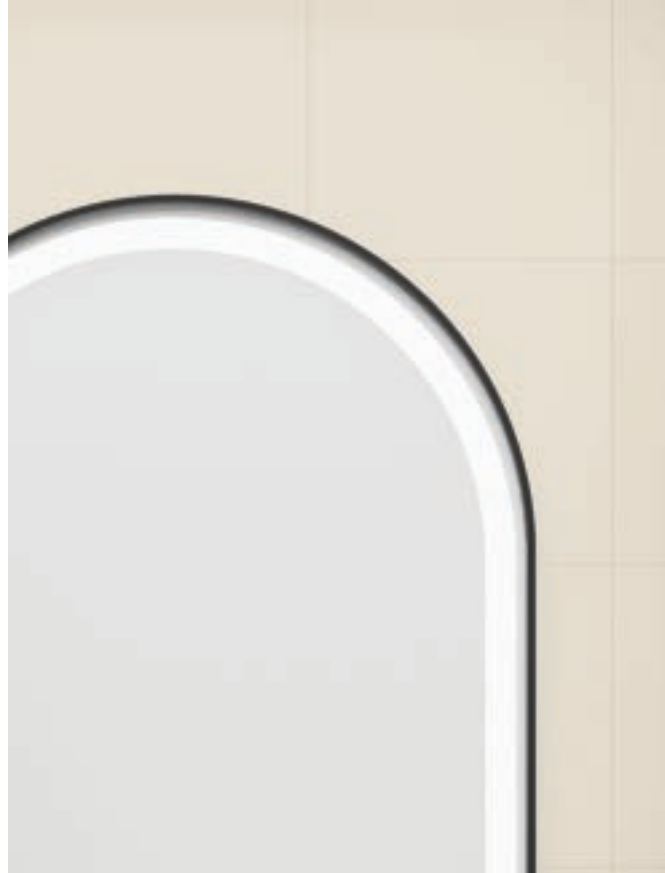

7358

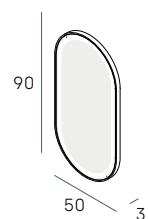

Dimensión/ Dimension	Ref/ Ref	On/Off Luz/ On/Off Light	Regulación Luz/ Dimmer	Antivaho/ Defogger	T.º de Luz/ Light Temp.	Lumens/ Lumens	Potencia/ Power
90 x 50	7358	✓	✓	✓	3000 °K 6500 °K	2500 Lm	30 W

Acabados/  
Finishes



Oro Cepillado  
Brushed Gold



Negro Mate  
Matt Black



Rosé Cepillado  
Brushed Rosé



# oval

LUZ FRONTAL  
FRONTAL LIGHT

7067

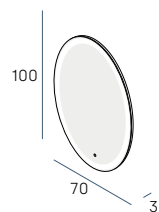

es Espejo Oval con conexión directa a red. Espejo ovalado de 4 mm de espesor y arenado de 35 mm. Luz frontal de 5500 °K y bastidor de PVC.

eng Oval mirror with direct connection to mains. Oval shape glass with 4 mm thickness and 35 mm sandblasting area. 5500 °K front light. PVC inner frame.

Sensor Touch/  
Touch sensor



Sensor touch on/off luz, antivaho y dimmer.  
On/off light, defogger and dimmer touch sensor.

Dimensión/ Dimension	Ref/ Ref	On/Off Luz/ On/Off Light	Antivaho/ Defogger	T.º de Luz/ Light Temp.	Lumens/ Lumens	Potencia/ Power
100 x 70	7067	✓	✓	5500 °K	1760 Lm	18 W

Sobre pedido  
Upon request

Cambio de temperatura de luz: 3000 °K o 4200 °K  
Change of light temperature: 3000 °K or 4200 °K







# circus

LUZ FRONTAL  
FRONTAL LIGHT

7094

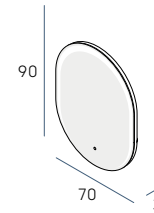

7095

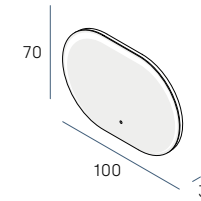

7096

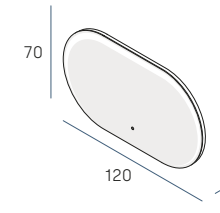

7097

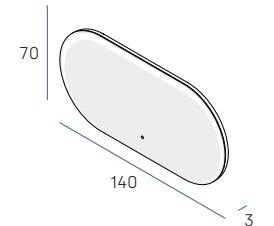

es Colección Circus con conexión directa a red.  
Cristal cápsula de 4 mm de espesor. Luz frontal de 5500 °K y bastidor de PVC con sistema de fijación regulable y nivelable.

ENG Circus collection with direct connection to mains.  
Capsule glass with 4 mm thickness. 5500 °K front light. PVC inner frame with adjustable fixing system.

Sensor Touch/  
Touch sensor



Sensor touch on/off antivaho.  
On/off antifog touch sensor.



Dimensión/ Dimension	Ref/ Ref	On/Off Antivaho/ On/Off Defogger	T.º de Luz/ Light Temp.	Lumens/ Lumens	Potencia/ Power
90 x 70	7094	✓	5500 °K	2480 Lm	24 W
100 x 70	7095	✓	5500 °K	2680 Lm	26 W
120 x 70	7096	✓	5500 °K	3083 Lm	30 W
140 x 70	7097	✓	5500 °K	3275 Lm	32 W

# swing

LUZ INTEGRADA  
INTEGRATED LIGHT

es Espejo Swing con conexión directa a red. Cristal cápsula de 4 mm de espesor. Luz integrada en el marco regulable de 3000 °K a 6500 °K y marco exterior de aluminio.

eng Swing mirror with direct connection to mains. Capsule glass with 4 mm thickness. With integrated dimmable light from 3000 °K to 6500 °K and aluminum outer frame.

Sensor touch/  
Touch sensor



Sensor touch on/off luz, antivaho y dimmer.  
On/off light, defogger and dimmer touch sensor.

7375

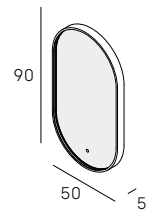

Dimensión/ Dimension	Ref/ Ref	On/Off Luz/ On/Off Light	Regulación Luz/ Dimmer	Antivaho/ Defogger	T.º de Luz/ Light Temp.	Lumens/ Lumens	Potencia/ Power
90 x 50	7375	✓	✓	✓	3000 °K 6500 °K	2165 Lm	30 W

Acabados/  
Finishes



Oro Cepillado  
Brushed Gold



Negro Mate  
Matt Black



Bronce Cepillado  
Brushed Bronze



# a m e d i d a /

## ES

Entendemos que en ocasiones buscas espejos más especiales o que se salgan de la norma. En Manillons Torrent afrontamos este reto y tratamos de darte la solución más adecuada para ello.

Para realizar este tipo de proyectos personalizados, consultar posibilidades y condiciones.

## ENG

We understand that sometimes you look for more special mirrors or that are out of regular norms. At Manillons Torrent we face this challenge and try to get the most appropriate solution.

For all these types of personalized projects, kindly consult possibilities and conditions.

# b e s p o k e

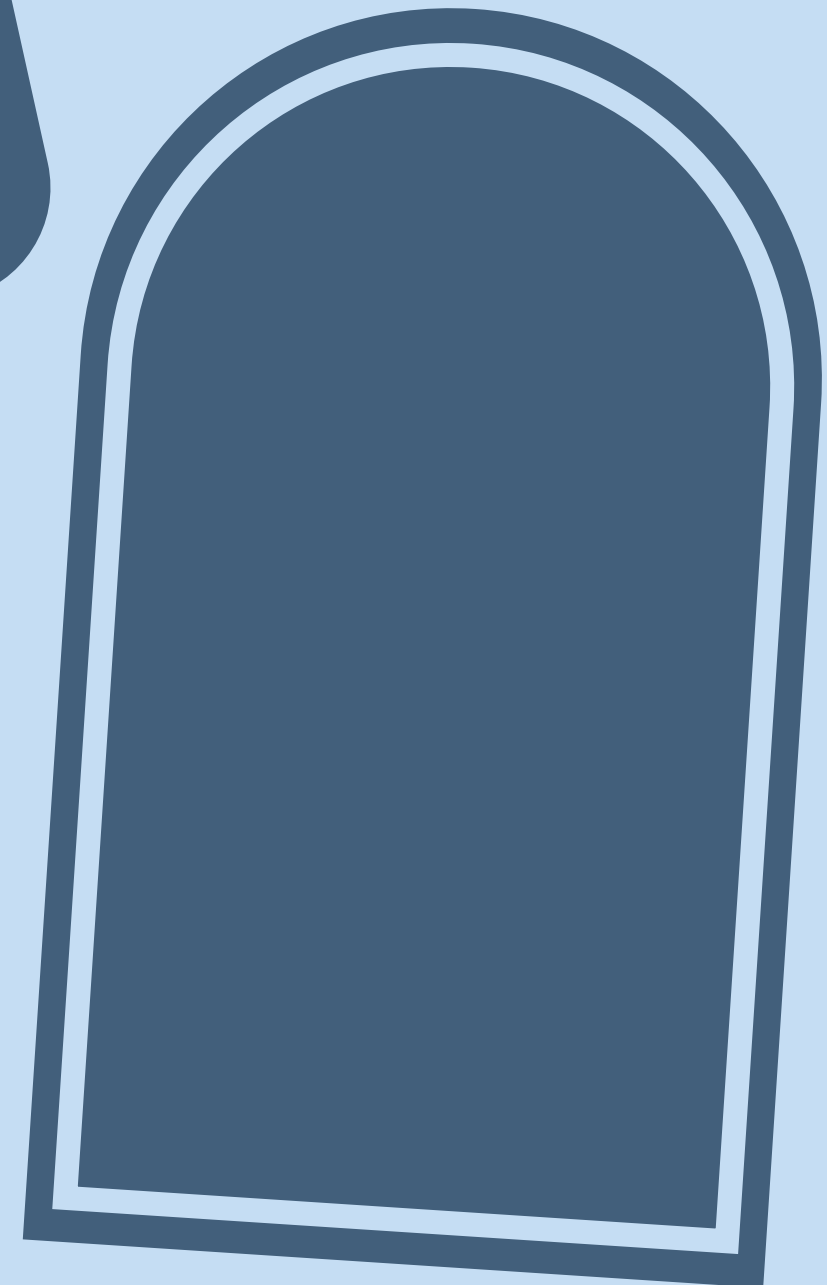
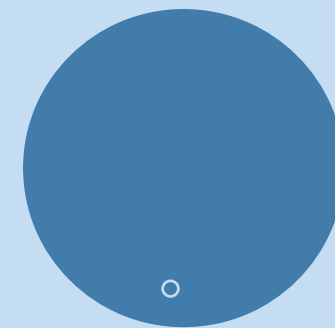
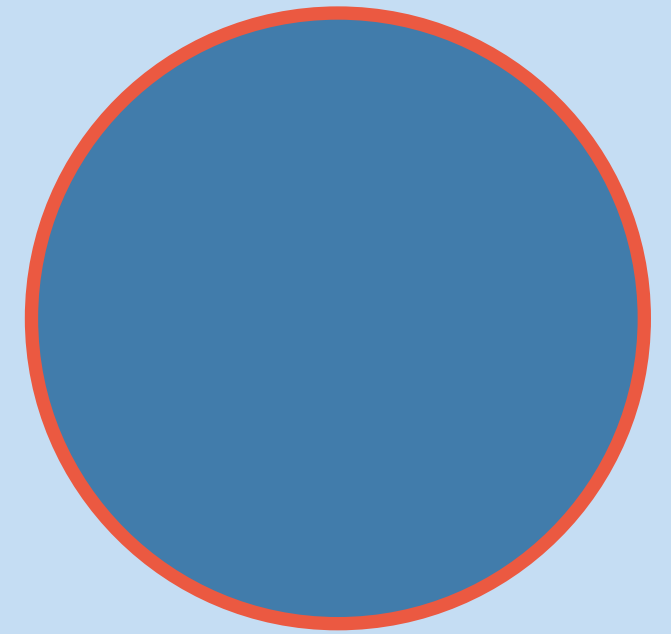
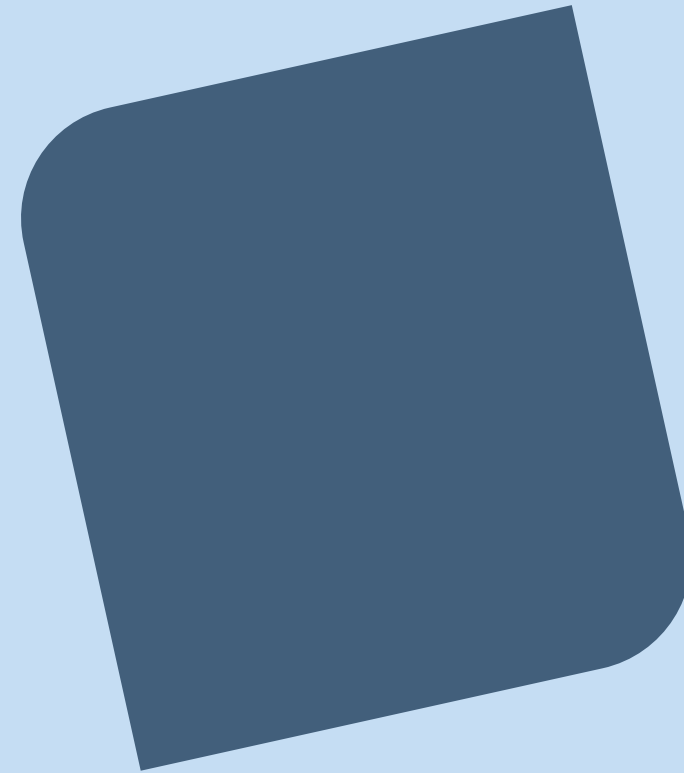

# info técnica

# /technical info.

Nuestro objetivo es ofrecerte espejos con un nivel de acabado de calidad, por ello nos aseguramos que todos ellos cumplan de forma notable todos los estándares de calidad en todos sus aspectos. A continuación detallamos todas esas características técnicas que tienen nuestros espejos, abordando aspectos como su nueva iconografía, los nuevos sistemas de fijación, los acabados disponibles o el nuevo sistema de packaging.

Our goal is to offer mirrors with the best quality level. This is why we ensure that all of them remarkably comply with all the quality standards at all stages. We are detailing herein all the technical characteristics that our mirrors have, pointing aspects such as their new iconography, the new fixing systems, the available finishes or the new packaging system.

fichas técnicas/  
technical data sheet



## sensores touch

Nuestros sensores touch rediseñados, se unifican y simplifican con el fin de mejorar tu experiencia. Podrás encontrar nuestros botones de manera individual o de manera combinada.



On/Off Luz  
Light On/Off

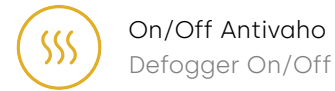

On/Off Antivaho  
Defogger On/Off

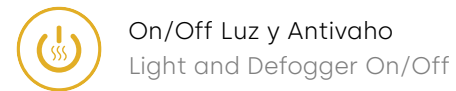

On/Off Luz y Antivaho  
Light and Defogger On/Off

## certificaciones

Dado que nuestro compromiso es ofrecerte espejos duraderos y de calidad, nos aseguramos de que estos cumplan todas las certificaciones necesarias para su buen funcionamiento.



Indicador clave de conformidad con la legislación de la UE para la libre circulación de productos en el mercado europeo.

Key indicator of compliance with EU regulations for the free movement of products in the European market.



Garantiza la restricción de ciertas sustancias peligrosas en aparatos eléctricos y electrónicos.

Ensures the restriction of certain hazardous substances in electrical and electronic equipments.



Verifica que el equipo es inmune a las perturbaciones externas y no producen señales que perturban otros equipos.

Verifies that the device is immune to external disturbances and does not produce any signals that disturb other equipments.

## touch sensors

Our new redesigned touch sensors are unified and simplified in order to improve your experience. You may find our buttons individually or combined.

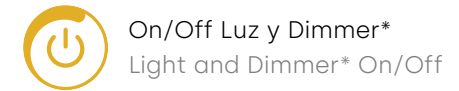

On/Off Luz y Dimmer\*  
Light and Dimmer\* On/Off

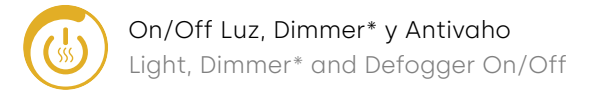

On/Off Luz, Dimmer\* y Antivaho  
Light, Dimmer\* and Defogger On/Off

\*Dimmer: intensidad de luz regulable.

\*Dimmer: adjustable light intensity.

## certifications

Since our commitment is to offer you long lasting and quality mirrors, we ensure that they meet all the necessary certifications for their proper functioning.

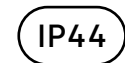

Los dispositivos eléctricos evitan la entrada y el contacto de sólidos y salpicaduras con las partes eléctricas.

Electrical devices prevent the entry and contact of solids and splashes with electrical parts.



Garantiza la seguridad de los dispositivos alimentados por energía eléctrica.

Ensures the safety of devices powered by electrical energy.



Aislamiento básico más aislamiento reforzado. Toma de tierra: excluida.

Basic insulation plus reinforced insulation. Ground connection: excluded.

## sistemas de fijación

## fixing systems

Nuestros cuatro sistemas de fijación están diseñados para facilitar la colocación de nuestros espejos, dado que cada sistema se adapta a las necesidades específicas de cada uno.

Our four fixing systems are designed to make the installation of our mirrors easy, as each system is adapted to the specific needs of each one.

### sist.01

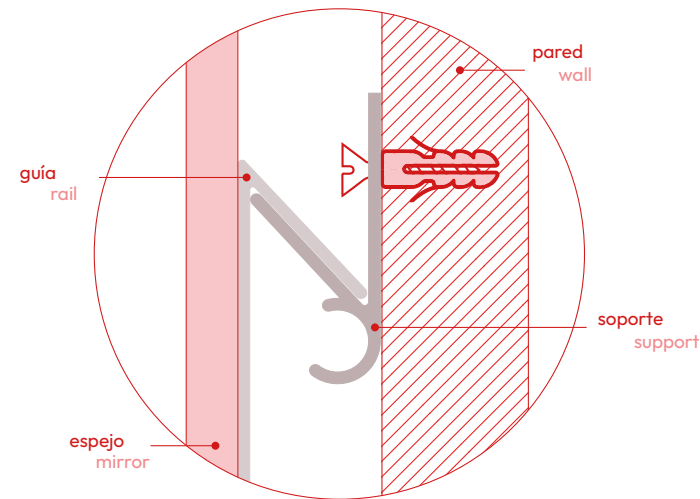
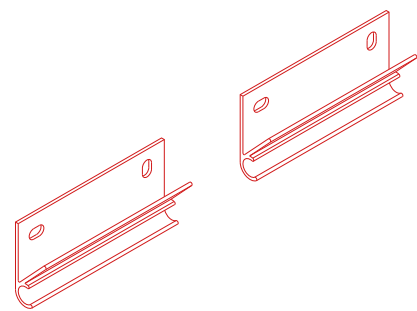

Tango 61  
Bolero 83

Swing 105

### sist.02

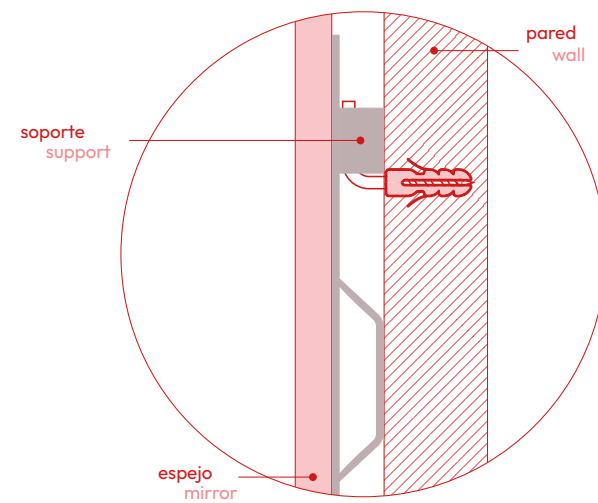
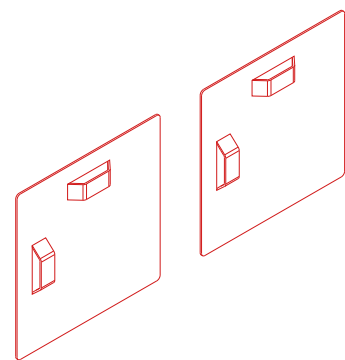

Basic 17  
Green 45

Alvero 65  
Luk 89

### sist.03

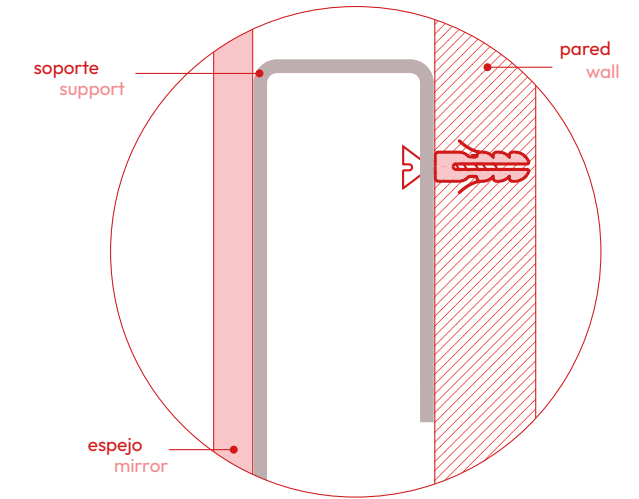
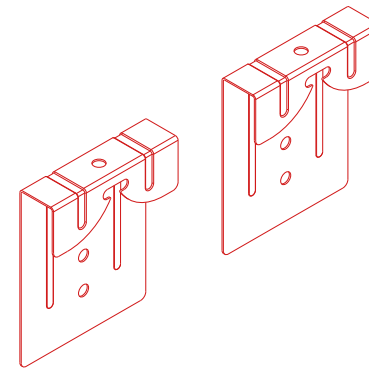

Nao 55  
Bruma 69  
Moon 71  
Sun 73  
Arena 77

Circular 79  
Eclipse 81  
Hula 85  
Aura 91  
Calas 93

Calas V. 95  
Eros 97  
Dante 99

### sist.04 / regulable y nivelable

### adjustable and levelling

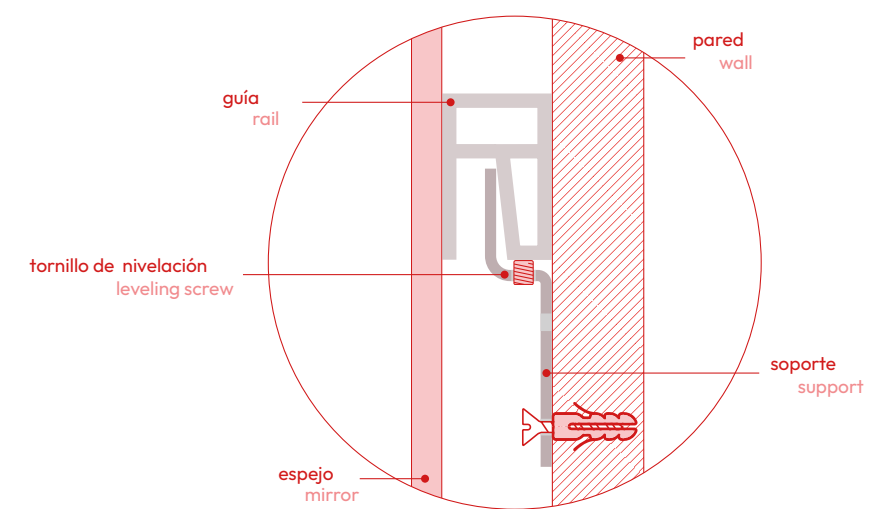
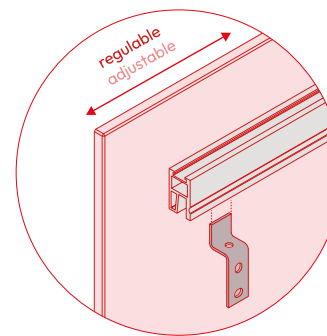

Retro 19  
Classic 23  
Mix 25  
Bria 27  
White 29  
Nova 31  
Clio 33

Line 37  
Marcus 39  
Lexus 41  
Brisa 47  
Ona 49  
Ondra 51  
Ondra V. 53

Vitara 57  
Vitara V. 59  
Alba 67  
Redondo 75  
Oval 101  
Circus 103



## acabados

Sabemos de la importancia que tiene el color dentro del baño. Los nuevos acabados elegidos cuidadosamente, buscan dar un acento de color a través de nuestros espejos.



047  
Bronce Cepillado  
Brushed Bronze



021  
Oro Cepillado  
Brushed Gold



058  
Rosé Cepillado  
Brushed Rosé



012  
Inox. Cepillado  
Brushed St. Steel

## finishes

We know how important the color is in the bathroom. Our new carefully chosen finishes give an accent of color through our mirrors.

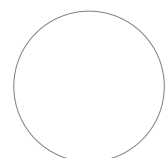

075  
Blanco Mate  
Matt White

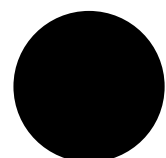

081  
Negro Mate  
Matt Black

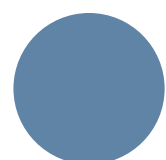

040  
Azul Atlántico  
Atlantic Blue

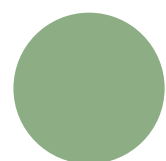

032  
Verde Reseda  
Reseda Green

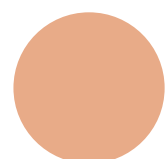

034  
Terracota  
Terracotta

Nuestros perfiles fabricados en aluminio se decoran mediante pintura epoxi con el objetivo de ofrecer unos acabados de alta calidad, dureza, resistencia y vida útil.

Our profiles made of aluminum are decorated using epoxy paint coating with the aim of offering high quality finishes, hardness, resistance and useful life.

# colores y acabados

## /colors & finishes





# nuevo embalaje

# /new packaging



Hemos rediseñado todo nuestro packaging con la finalidad de ofrecer unas cajas más eficientes, reduciendo los elementos del embalaje y eliminando las grapas. De esta manera, facilitamos el proceso de desmontaje y su posterior reciclabilidad. Introducimos el uso de cartones con certificación FSC®, reforzando así nuestro compromiso hacia una responsabilidad ecológica. Todo ello sin comprometer la seguridad de nuestros espejos.

We have redesigned our packaging in order to offer more efficient boxes, reducing packaging elements and eliminating staples. This way we facilitate the disassembly process and its recyclability. We introduced the use of FSC® certified cardboard, thus reinforcing our commitment to ecological responsibility. All this without compromising the safety of our mirrors.

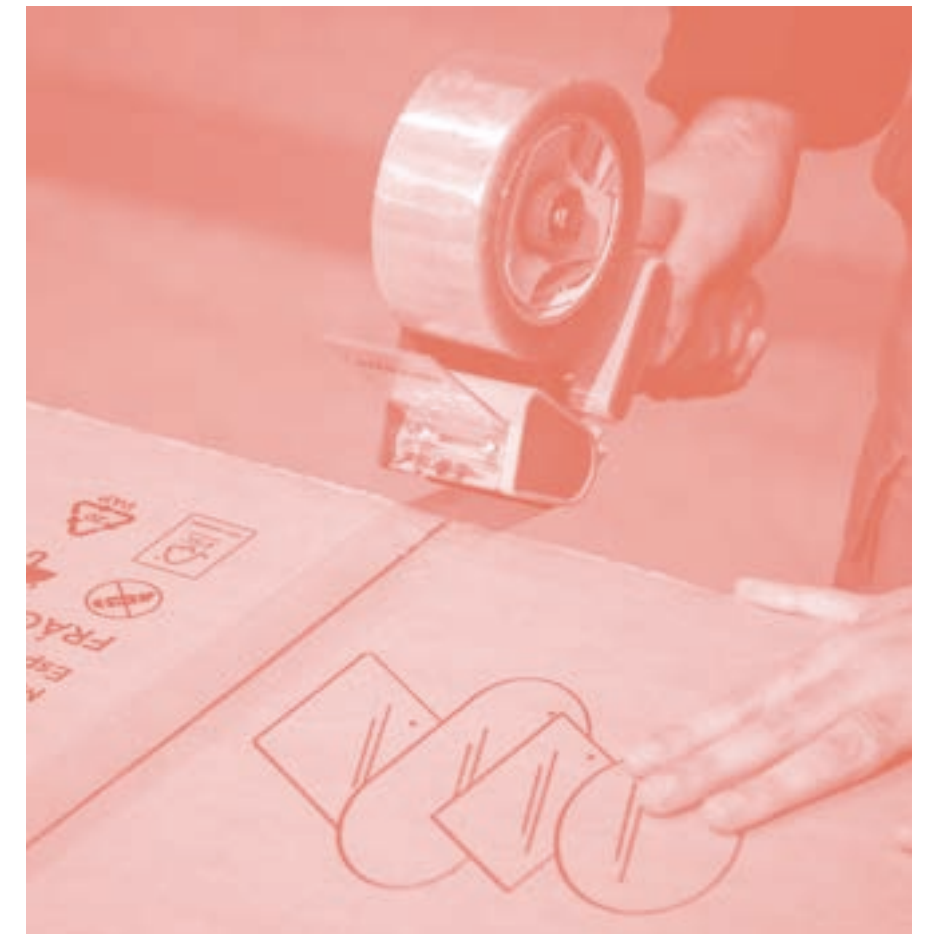

# expositores /displays

expositor 1  
display 1



ref. 7744  
De pie 115 x 197 x 50 cm  
Freestanding 115 x 197 x 50 cm  
\*El PVP indicado no incluye espejos.  
\*The price indicated does not include mirrors.

expositor 2  
display 2

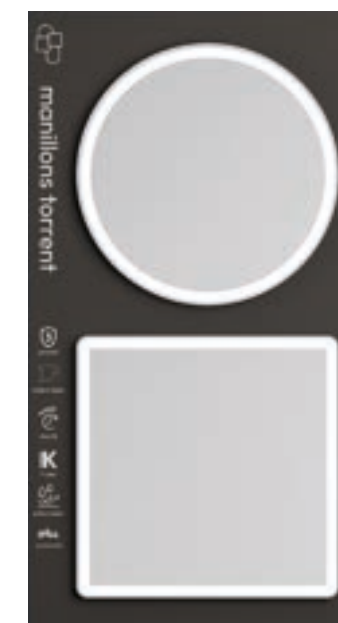

ref. 7745  
A pared 120 x 190 cm  
Wall mounted 100 x 190 cm  
\*El PVP indicado no incluye espejos.  
\*The price indicated does not include mirrors.

expositor 3  
display 3



set 1  
ref. 7746  
A pared 40 x 40 cm  
Wall mounted 40 x 40 cm



set 2  
ref. 7747  
A pared 40 x 40 cm  
Wall mounted 40 x 40 cm

Queremos ayudarte a llevar nuestros espejos a tu tienda, por ello te presentamos nuestra nueva línea de expositores completamente rediseñada para cautivar con nuestros espejos. Para más información consultar con el departamento comercial.

We want to help you bring our mirrors to your store, so we present our new line of displays completely redesigned to captivate with our mirrors. For more information, please contact our sales department.

legal

/legal

Manillons Torrent asegura que los espejos comercializados se encuentran libres de cualquier defecto de fabricación en el momento de la entrega. Además, garantizamos que, bajo una correcta instalación y uso en entornos privados, cumplen rigurosamente con las especificaciones indicadas en el catálogo o, en su defecto, en la ficha técnica del producto correspondiente.

El hecho de cursar un pedido a Manillons Torrent, tanto directamente a la empresa como a través de nuestros delegados de zona, implica la aceptación de estas condiciones generales.

## condiciones de venta

### PEDIDOS

Para evitar errores y, por lo tanto, futuras incidencias, se aconseja que los pedidos se hagan por correo electrónico, indicando nuestra referencia y acabado.

Impuestos vigentes no incluidos en los PVPs del catálogo.

Portes pagados en todo el territorio peninsular a partir de 100€ netos por expedición. Los envíos inferiores a este importe llevarán **un cargo de 8€** en concepto de portes. En el caso de Baleares, Portugal, Andorra, Ceuta y Melilla este cargo será de **12€**.

**En espejos con medidas o acabados especiales no se admiten devoluciones.** Tras el estudio de viabilidad por parte del departamento correspondiente, se pasará el presupuesto para su aprobación. Una vez aprobado y firmado el presupuesto no se admitirán cambios. El plazo de entrega de estos artículos especiales a consultar.

### ROTURAS

Al recibir un envío debe comprobar inmediatamente el estado de la mercancía y que ésta coincida con el albarán que se adjunta.

Si detectan cualquier **anomalía o rotura** durante la recepción de la mercancía, **debe ser comunicada a fábrica o al transportista inmediatamente**. Si el material está en mal estado, no deben aceptarlo.

Las **reclamaciones por rotura** de algún producto deberán ser notificadas a fábrica en un **plazo máximo de 24 horas**. Si no se cumple este requisito, en ningún caso nos haremos cargo de la reclamación.

No olvide indicar el número de albarán en cualquier reclamación.

### DEVOLUCIONES

Cualquier devolución de mercancía **deberá ser autorizada** siempre por nuestro departamento comercial y con autorización del delegado de la zona.

No se admitirán devoluciones que no sean por defectos de fabricación del producto o de alguno de sus componentes, y siempre y cuando esté dentro del período de garantía.

En el caso de ejercicio de desistimiento por parte del cliente y siempre que **la devolución no sea imputable** a Manillons Torrent, (anulación de pedido sin previo aviso, error en las medidas o acabados a la hora de tramitar el pedido a fábrica, etc.) **la devolución se efectuará a portes pagados y se aplicará una depreciación del 25%** sobre el importe facturado, en concepto de manipulación y cambio de embalaje. En el caso de que el cliente efectúe la devolución del espejo por su propia agencia de transporte y llegase roto a nuestras instalaciones, Manillons Torrent quedará exento de toda responsabilidad y el cliente deberá reclamar a su agencia de transporte.

En ningún caso **nos haremos cargo de una devolución que no haya sido autorizada** por nuestro departamento comercial o remitida por otras agencias que no sean las autorizadas por nosotros.

En caso **de cambio de mercancía por defecto de fabricación**, se volverán a enviar los artículos **con cargo**. El abono se efectuará tan pronto como las piezas defectuosas estén en nuestro poder y hayan sido revisadas en fábrica.

### CONDICIONES DE PAGO

Todo importe **inferior a 120€**, se girará a la vista; indistintamente de las condiciones pactadas.

**Giro 30 Días** fecha factura o forma de pago pactada a partir de 121€.

### IMPAGOS

En el caso de impago, **todos los pedidos pendientes** quedarán retenidos hasta haber cancelado totalmente la deuda.

En caso de litigio, ambas partes se someterán exclusivamente al fuero y jurisdicción de los Tribunales de Valencia, rehusando a los que correspondieren por fuero propio.

## garantía

Manillons Torrent ofrece la garantía en todos sus productos ante cualquier defecto de fabricación desde la fecha de adquisición del producto, siempre y cuando su uso e instalación hayan sido efectuados de acuerdo con las instrucciones indicadas. El periodo de garantía contemplado para los espejos y espejos con luz LED es de 3 años.

## mantenimiento

La limpieza de nuestros productos debe efectuarse con un paño ligeramente humedecido con agua (sin disolventes ni abrasivos).

es

Manillons Torrent ensures that the mirrors marketed are free of any manufacturing defect at the time of delivery. In addition, we guarantee that, under a correct installation and use in private environments, they rigorously comply with the specifications indicated in the catalog or, failing that, in the corresponding product technical data sheet.

The fact of placing an order to Manillons Torrent, either directly to the company or through our area delegates, implies the acceptance of these general conditions.

## terms and conditions of sale

### ORDERS

To avoid errors and therefore, future incidents, it is recommended that orders are placed by e-mail, indicating our reference and finish.

Taxes are not included in catalog prices.

Shipping costs paid in all the peninsular territory from 100€ nett per shipment. Shipments below this amount will be **charged 8€** for transport cost. In the case of Balearic Islands, Portugal, Andorra, Ceuta and Melilla transport cost **will be 12€**.

**Return of mirrors with special measures or finishes are not allowed.** After the study by our corresponding department, the budget will be offered to you for approval. Once approved and signed, no change will be admitted. Please consult the delivery time for these special items.

### REPLACEMENTS

Upon receipt of a shipment, you should immediately check goods condition and that they match the accompanying delivery note.

If you notice **any anomaly or breakage** upon receipt of the goods, **you must immediately notify the factory or the carrier**. If the material is in bad condition, do not accept it.

**Claims for breakage** of any product must be reported to the factory **within 24 hours**. If this requirement is not met, the claim will not be accepted.

### RETURNS

Any return of products **must always be authorized** by our sales department and with the approval of the area delegate.

Returns will not be accepted unless they are due to product manufacturing defects or any of its components, and as long as it is within the warranty period.

In case of withdrawal by the customer and provided that **the return is not attributable** to Manillons Torrent, (cancellation of the order without prior notice, error in the measurements or finishes when processing the order to the factory, etc.), **the return will be made under transport paid basis and a 25% deduction will be applied** to the invoiced amount as handling and packaging change. In the event that the customer returns the mirror with his own transport company, and it reaches our premises broken or damaged, Manillons Torrent will be exempt from any responsibility and the customer will have to complain to his transport company. In no case we will be responsible for any return not authorized by our sales department or sent by other agencies not authorized by us.

In the event of an exchange due to a manufacturing defect, **the items will be reshipped and charged**. Refund will be made once the defective parts are in our possession and have been inspected at the factory.

### TERMS OF PAYMENT

Any payment for amount **less than €120** will be paid at sight, regardless of the agreed conditions.

**30 days payment** from invoice date or agreed payment method from **€121**.

### UNPAID INVOICES

In the event of **any unpaid invoice, all pending orders** will be held until the debt has fully been settled.

In case of litigation, both parties will submit exclusively to the jurisdiction of the Valencia Courts, refusing to their own jurisdiction.

## warranty

Manillons Torrent offers warranty on all its products against any manufacturing defect from the date of purchase of the product, provided that its use and installation have been carried out in accordance with the instructions provided. The warranty period for mirrors and LED mirrors is of 3 years.

## maintenance

Our products should be cleaned with a cloth slightly moistened with water (no solvents nor abrasives).

eng

121

### Un proyecto de

Manillons Torrent

### Dirección de arte

David Collado Truman  
Diego Sanz Palomares

### Diseño y maquetación

David Collado Truman  
Diego Sanz Palomares

### Traducciones

Manolo Sánchez

### 3D Art

Moka Render  
David Collado  
Clara Salvador

### Fotografía

Manillons Torrent Studio

### Impreso en España

Gráficas Selvi

### Papel

Diva Art Duo de 250 gr.  
Magno Satin de 150 gr.



Espejos diseñados por el equipo de diseño de Manillons Torrent.

Manillons Torrent se reserva el derecho a anular o modificar los productos o cualquiera de sus atributos que aparecen en este catálogo.

La reproducción de los colores es aproximada.

Mirrors designed by the Manillons Torrent design team.

Manillons Torrent reserves the right to cancel or modify the products or any of their attributes that appear in this catalogue.

The reproduction of the colours is approximate.

### MANILLONS TORRENT

Ctra. Masía del Juez,  
54-2 Pol. Ind. Masía del Juez  
46909 Torrent (Valencia), España  
manillons1@manillons.com  
T. +34 961 564 753  
www.manillons.com

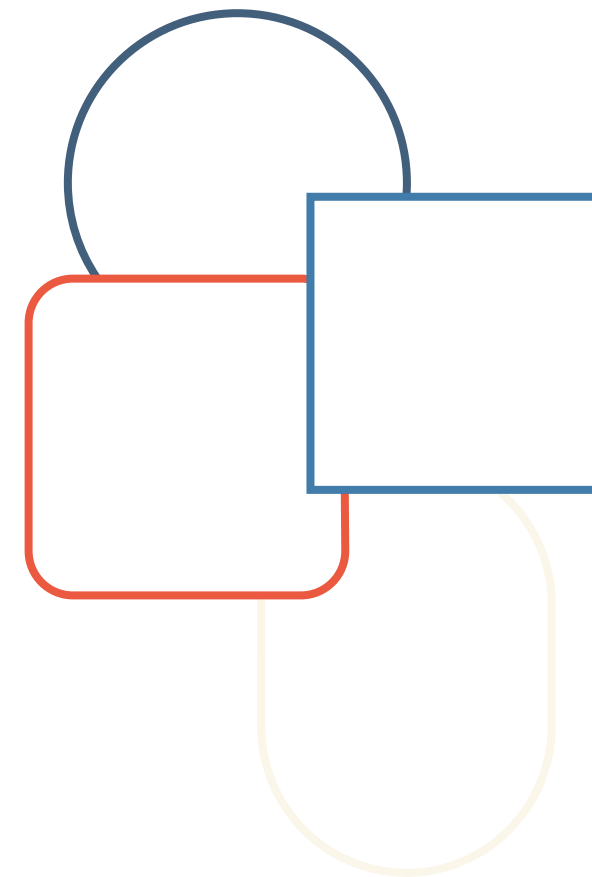







[www.manillons.com](http://www.manillons.com)